

ISSN 2224-2007

TECHNOLOGY FOR ADVANCEMENT  
CENTER OF EXCELLENCE



# MIST Journal of Science and Technology

Volume- 7  
Issue- 1  
August 2019

Military Institute of Science and Technology (MIST)  
[www.mist.ac.bd](http://www.mist.ac.bd)





## **MILITARY INSTITUTE OF SCIENCE AND TECHNOLOGY (MIST)**

**Mirpur Cantonment, Dhaka-1216, Bangladesh**



**INAUGURAL CEREMONEY OF MIST**

**ON 19 APRIL 1998**

**HONOURABLE PRIME MINISTER OF PEOPLE'S REPUBLIC OF BANGLADESH**

**SHEIKH HASINA**

**UNVEILING THE FOUNDATION PLAQUE**

**MIST**

**Technology for Advancement**



# **MIST JOURNAL OF SCIENCE AND TECHNOLOGY**

THE ANNUAL TECHNICAL JOURNAL

OF

MILITARY INSTITUTE OF SCIENCE AND TECHNOLOGY

Volume-7	Issue-1	August 2019
----------	---------	-------------

---

MIST, Mirpur Cantonment, Dhaka-1216, Bangladesh

# EDITORIAL BOARD

## Chief Patron

Major General Md Wahid-Uz-Zaman, ndc, aowc, psc, te  
Commandant, MIST

## Editor-in-Chief

Colonel Molla Md. Zubaer, te  
A/Director Research and Development, MIST

## Editor

Lieutenant Colonel Muhammad Sanaulah, psc, Engrs  
General Staff Officer-1 (Research), MIST

## Associate Editors

Major Md Mohammad Shawkat Ali, Sigs  
Major Md Manwarul Haq, PhD, AEC  
Major Md Ferdausur Rahman, PhD, AEC  
Assistant Professor Selin Yasmin

## Editorial Advisors

Brig Gen Md. Wahidul Islam, SUP, ndc, psc  
Director Academic and Dean Faculty CE, MIST

Colonel M Mahmudul Hassan  
Director Administration, MIST

Colonel Md Habibul Huq, psc  
Colonel Staff, MIST

## Proof Readers

Md Morshed Mahmud – SAE (Drafting)  
Nurun Naher – SAE (Drafting)

## Disclaimer

The analysis, opinions and conclusions expressed or implied in this Journal are those of the authors and do not necessarily represent the views of the MIST, Bangladesh Armed Forces or any other agencies of Bangladesh Government. Statements of fact or opinion appearing in MIST Journal are solely those of the authors and do not imply endorsement by the editors or publisher.

**ISSN: 2224-2007**

## Initial Submission

Initial Submission of manuscripts and editorial correspondence should be sent to the MIST, Mirpur Cantonment, Dhaka-1216, Bangladesh. Tel: 88 02 8034194, FAX: 88 02 9011311, should consult the Notes for contributions at the back of the Journal before submitting their final draft. The editors cannot accept responsibility for any damage to or loss of manuscripts.

## Subscription Rate (Single Copy)

Individuals : BDT 300 / USD 05 (including postage)  
Institutions : BDT 375 / USD 08 (including postage)

## Published by Military Institute of Science and Technology, Bangladesh

All rights reserved. No part of this publication may be reproduced, stored in retrieval system, or transmitted in any form, or by any means, electrical, photocopying, re-cording, or otherwise, without the prior permission of the publisher.

## Designed and Published by:

Research and Development Wing, MIST

# FOREWORD

Efficiency and Effective contribution to the nation by a degree awarding institution is adjudicated considering the innovative and fundamental research activities carried out by that institution. No one can deny the impact of research in development of critical thinking, creativity, problem solving, self-confidence and intellectual independence of students and teachers as well. MIST Journal of Science and Technology pictures the fundamental contributions in research work on global and local interests related to science and Technology.

MIST, a growing academic institution is focused in the field of developing quality technical education and research to match up itself with other renowned Engineering Institutions at home and abroad. It has widened its effort to increase the number of PhD faculty members in all the engineering departments presently under it. MIST maintains a constant link with domestic industries and entrepreneurs for hands-on training of graduates.

MIST Journal of Science and Technology pictures the fundamental contributions in research work on global and local interests related to science and Technology. A good number of selected works has been published in this Journal. I firmly believe that the readers will benefit from this Journal.

I congratulate all the authors who have contributed to this journal. My special thanks to the editorial board and associated personnel for their relentless efforts in publishing the current issue of the journal, "MIST Journal of Science and Technology". May Almighty Allah bless us all in the pursuit of the motto of the institute, "Technology for Advancement" with His boundless blessings and adorn MIST as "Center of Excellence".



**Major General Md Wahid-Uz-Zaman, ndc, aowc, psc, te**  
Commandant  
Military Institute of Science and Technology  
and  
Chief Patron, MIST Journal of Science and Technology

# EDITORIAL

Research activity engages and empowers students in hands on learning and also provides effective career preparation which promotes interest in graduate education as well. MIST being one of the leading engineering institutions, patronizes multifarious research activities at all engineering departments related to national and international issues.

The scope of the journal covers the full range of research, evaluation, design, operations and functioning of all engineering disciplines. Research activities provides platform and empowers faculty members and students for effective career preparation in engineering field.

MIST always promotes research works in applied science and Technology and this Journal publishes fundamental, objective and innovative research works from writers of different universities and institutions from home and abroad.

I express my deepest gratitude to Major General Md Wahid-Uz-Zaman, ndc, aowc, psc, te, the Chief Patron of MIST journal of Science and Technology for his invaluable and dynamic guidance during editorial period of volume-7, Number-1, August 2019 issue. I must mention the hard work and relentless support of members of the editorial board. I also express sincere thanks to the advisory board for their whole-hearted cooperation in publishing the journal. I believe this publication will raise the interest among the learned readers in relevant fields.



**Colonel Molla Md. Zubaer, te**  
Acting Director  
Research and Development Wing  
Military Institute of Science and Technology  
and  
Editor in Chief, MIST Journal of Science and Technology

# THE NULL EFFECT OF CROSS SECTIONS OTHER THAN THE MAXIMUM PITTED CROSS SECTION ON STRENGTH REDUCTION OF AGED MARINE PLATES SUBJECTED TO UNIAXIAL TENSILE LOADING

**Commodore M Munir Hassan (Retd)<sup>(1)</sup>, Tasmia Hoque<sup>(2)</sup> and Lieutenant Colonel Muhammad Rabiul Islam, PhD<sup>(3)</sup>**

1. Professor, Department of Naval Architecture and Marine Engineering  
Military Institute of Science and Technology, Dhaka,  
E-mail: Bangladesh munhas2007@yahoo.com

2. Lecturer, Department of Naval Architecture and Marine Engineering  
Military Institute of Science and Technology, Dhaka  
E-mail: Bangladesh shoily002@gmail.com

3. Instructor Class-A, Department of Naval Architecture and Marine Engineering  
Military Institute of Science and Technology, Dhaka  
E-mail: Bangladesh rabiul@mist.ac.bd

## ABSTRACT

It is of essential importance to predict the strength reduction due to pitting corrosion for a proper condition assessment of aged ships. The crucial location of maximum pitting as well as the heavy unevenness of the metal surface creates difficulties for the surveyors to perform the survey. Empirical formula based on statistical data can assess the strength reduction due to pitting on the basis of damage intensity where the strength reduction is only a function of maximum pitted cross section. In this study, the formula is established again by nullifying the effect of other cross sections on the strength reduction except the maximum pitted cross section. This null effect of less pitted cross sections will increase the surveyors' confidence to concentrate only on the maximum pitted cross section. A series of finite element analysis is carried out where MSC NASTRAN nonlinear implicit analysis code has been used in large deformation analysis of two different pitted marine steel rectangular plate samples. The pitting patterns of different intensity used in this study were generated by other researchers using a probabilistic corrosion model.

**Key words:** Strength Reduction, Pitting Corrosion, MSC NASTRAN, Nonlinear Implicit Analysis, Probabilistic Corrosion Mode

## 1.0 INTRODUCTION

Condition assessment is a very important scheme as many vessels are removed from service before reaching the end of their designed life. A Condition Assessment Program is aimed at determining and assessing the actual technical condition of hull and/or machinery, electrical installation and cargo related systems at a given point of time by surveys and investigations. The purpose of a Condition Assessment Survey is to analyze the remaining strength of the hull structure.

Corrosion wastage is a prominent cause of age related deterioration of steel structures. Metal degrades locally in pit forms reducing strength and deformability, which are main salient features for integrity of steel structures. For a proper condition assessment of aging ships, it is of essential importance to predict the strength and absorbing energy during collapse and/or fracture of corroded plate [1]. According to Nakai et al. [2] it is very important to investigate the effect of corrosion wastage not only on overall strength but also on local strength. They

have investigated shape of corrosion pit on a single hull tanker and found circular cone shaped pit on hold frame of bulk carrier and spherical shaped pit on the bottom shell of the tanker. The effect of corrosion is basically the geometric effect and chemistry does not come into play [3]. It is thus of great importance to consider actual shape of pits in study. Paik et al. [4-5] studied the ultimate strength behavior and Sumi [6-7] estimated tensile strength, bending strength and deformability of steel corroded plates considering two types of pit shape. In the present study it is aimed to enhance the periodic survey of Bangladesh marine structure in case of pitted steel plate considering the actual pit shape that observed in Bangladesh marine plate. Strength reduction in a large pitted plate and part of that plate containing maximum pitted cross section is compared by nonlinear finite element analysis. For that material, true stress-true strain relationship is defined from engineering stress strain which is investigated with the help of tensile test by universal testing machine.

### 2.0 ACTUAL PIT SHAPE OF BANGLADESH MARINE CORRODED PLATE

Munir Hassan investigated the actual pit shape of Bangladesh marine corroded plate in part of his PhD research. He collected a number of pitted plates from different source of Bangladesh inland marine structures and prepared the surfaces by sand blasting. Replication of the surface was done by using fiber glass. Finally he observed the pit cross section as conical (Fig 1). In this study the same pit shape is considered.



Fig 1. Replication of pitted surface.

The probabilistic corrosion model that was proposed by Yamamoto and Ikegami [8] can quantitatively evaluate generation and progress of corrosion. They estimated parameters governing their probabilistic model for four different locations of ships. M.R. Islam [9] generated data sets by using ‘Monte Carlo Simulation’ and Three-dimensional computer aided design software ‘RHINOCEROS’ [10] was used to model the corrosion surface by the NURBS (Non Uniform Rational B-Spline) surfaces.

In the current study the effect of cross sections other than the maximum pitted cross section is nullified by selecting a part of total pitted surface which includes the maximum pitted cross section. Here the length of part is chosen as 20 mm [a random choice] [10mm to each side of the maximum pitted cross section]. So the size of the part is 20 x original breadth of the sample and the location of maximum pitted surface is at middle of the part. The original size of the pitted plate specimen is 200 x 38mm. The location of maximum pitted cross section within the total pitted surface is traced by calculating the average cross sectional material diminution. So the final size of the pitted surface for analysis is 20 x 38mm. The original locations of maximum pitted cross section and cross sections at each side of 10mm is remained same in finite element model (Fig2).

Pit Intensity (DOP: Degree Of pit Intensity)	Total Pitted Surface	Partial Pitted surface containing the maximum pitted cross section at middle
DOP 19		
DOP 51		
DOP 73		
DOP 92		

Fig 2. Simulation images of pitted surfaces.

### 3.0 MATERIAL DEFINITION

In this study an elastoplastic material is considered. The material definition flow chart is shown in fig 3. True stress strain curve is produced from engineering stress-strain by using the following simple equation.

$$\epsilon_T = \ln(1 + \epsilon_e) \quad \text{and} \quad \sigma_T = \sigma_e(1 + \epsilon_e)$$

Here,  $\sigma_e$  = engineering stress,  $\epsilon_e$  = engineering strain;

$\sigma_T$  = True stress,  $\epsilon_T$  = true strain.



Two types of intact plate, class and local were collected and they were tested by UTM to obtain the engineering stress-strain curve (Fig 4, Fig 5). The chemical composition of the plates was also tested and shown in Table I along with the mechanical properties in Table II.

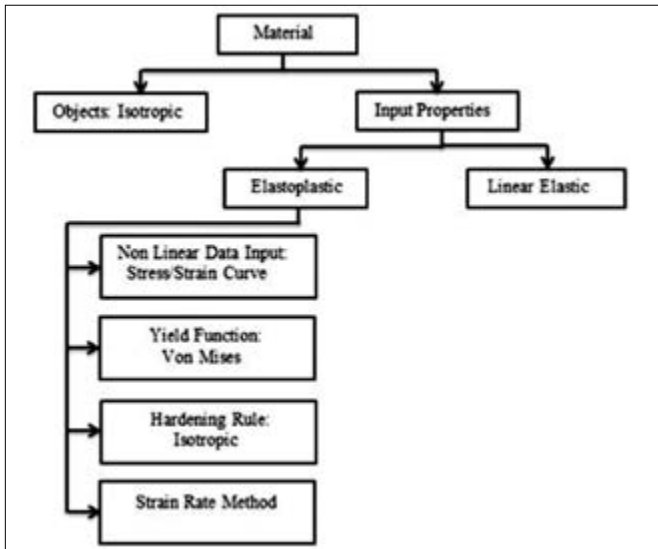

Fig 3. Material definition in MSC Nastran.

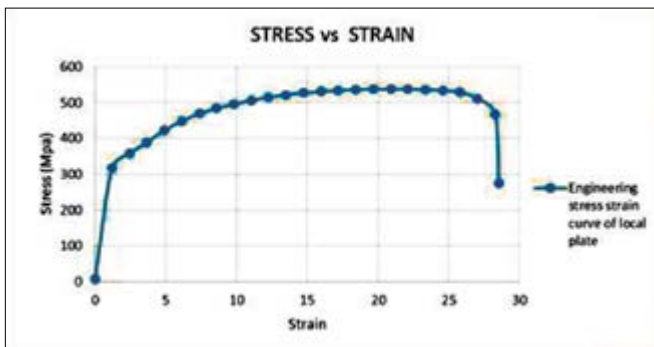

Fig 4. Engineering stress strain curve of local plate.



Fig 5. Engineering stress strain curve of class plate.

In case of large and non-uniform deformation the engineering/nominal quantities of stress and strain are valid up to ultimate limit in their true form and can be calculated from engineering part. That is why, the analysis has been done up to the ultimate limit

in this study. The engineering stress strain has been converted into true stress strain using equation stated above. These curves were used as material definition.

The true stress strain curve obtained using the formula is shown in fig 6 and fig 7.

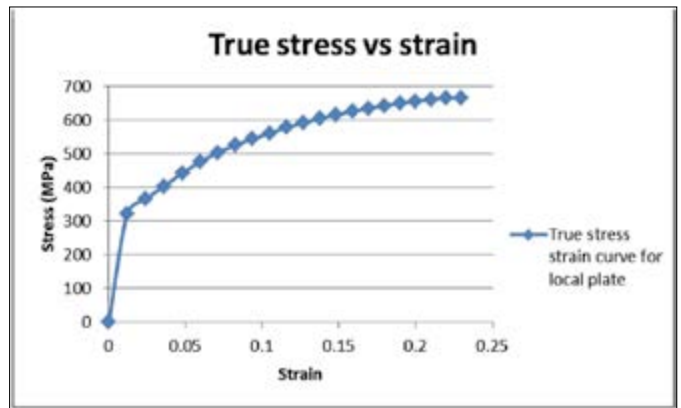

Fig 6. True stress strain curve of local plate.

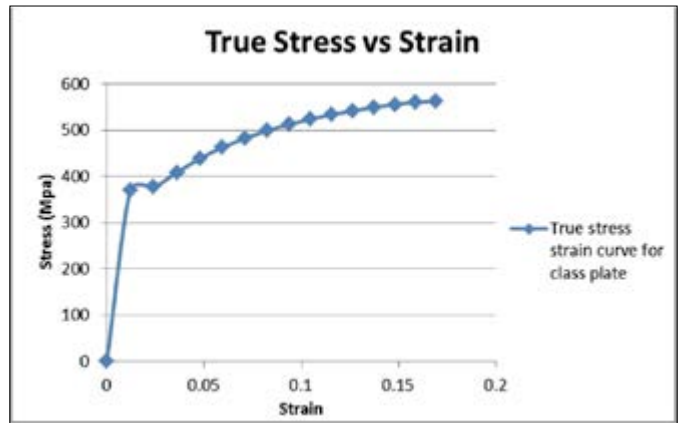

Fig 7. True stress strain curve of class plate

TABLE I. CHEMICAL COMPOSITION

Material	Fe	Mn	P
LOCAL PLATE	98.71	0.606	0.19
CLASS PLATE	99.35	0.426	0.22

TABLE II. MECHANICAL PROPERTIES

Material	Yield Strength (MPa)	Young's Modulus (MPa)	Tensile Strength (MPa)
LOCAL PLATE	316.98	26408.64	537.8
CLASS PLATE	365.54	30180.03	478.98

### 4.0 FINITE ELEMENT MODEL

The finite element model of test specimen is generated by ‘MSC PATRAN – Academic Version’ [11] using 8-node hexahedron elements (Fig 8(a)). The loading condition is uniaxial and static where all the nodes of one end kept constrained in all directions.

The current model was generated for total pitted surface and total surface but partially pitted which contains maximum pitted cross section. Due to the element number limitation in academic version, the minimum size in loading direction could be

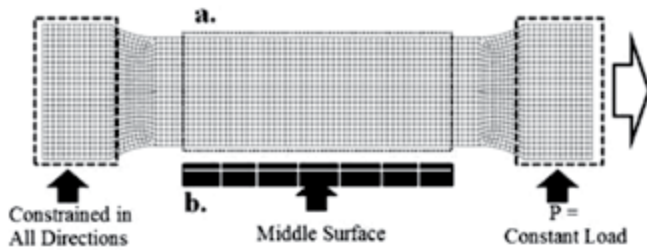
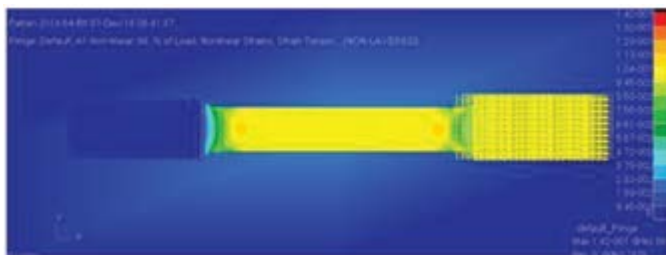

**Fig 8.** Finite Element Modeling: (a) Boundary Condition; (b) A mid surface is introduced.

The most reasonable element size 1x1x1mm could not be used due to limitation of academic version and DD model was generated having elements of 2x2x2 mm.

### 5.0 FINITE ELEMENT ANALYSIS RESULT

The validation of input properties was ensured by the FEA of the intact plate (Fig 9) when output curve from the simulation superimposed on the input stress strain curve (Fig 10: Local Plate).



**Fig 9.** FEA of intact local plate.

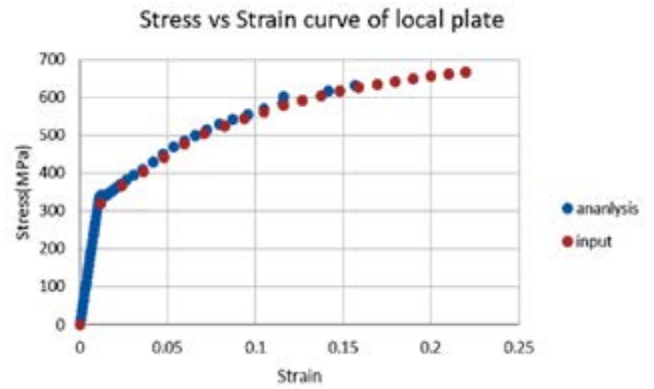

**Fig 10.** Validation curve of intact local plate properties

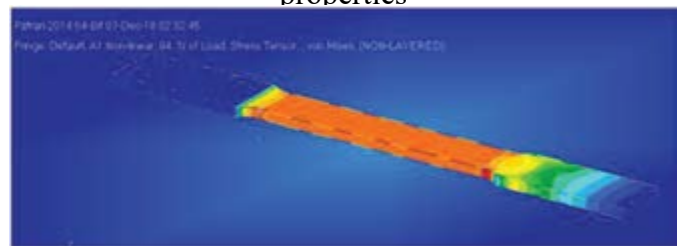
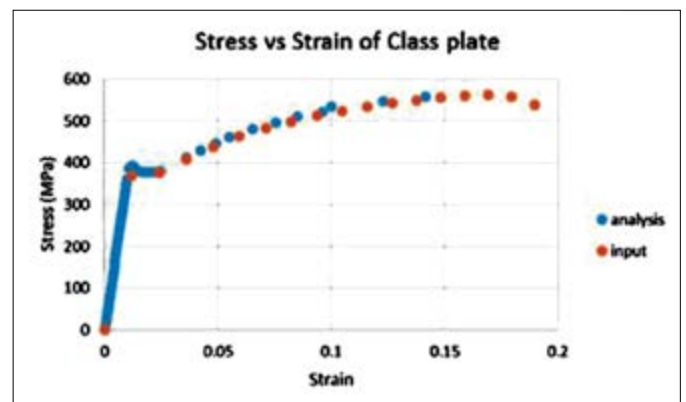

**Fig 11.** FEA of intact class plate.

In the similar manner the class plates were also simulated and they result in superimposition of input and output curves (fig 12) as it does for local plates.

Later on, non-linear implicit finite element analyses were conducted for both pitted surface and partially pitted surface containing maximum pitted cross sectional area using material definition of class and local plate considering conical pits (fig 13(a), fig 13(b)).

Here the superimposition of two curves indicates that total pitted surface and partially pitted surface absorb equal quantity of load to reach to its ultimate limit of stress (fig 13(c)).



**Fig 12.** Validation curve of intact class plate properties.

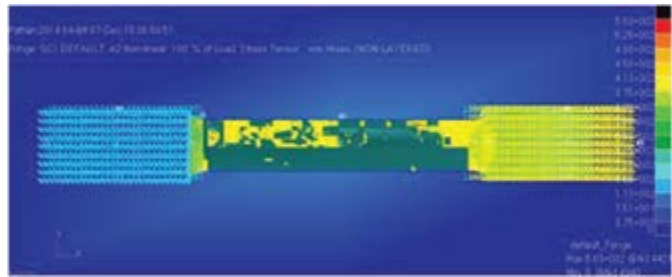

(a)

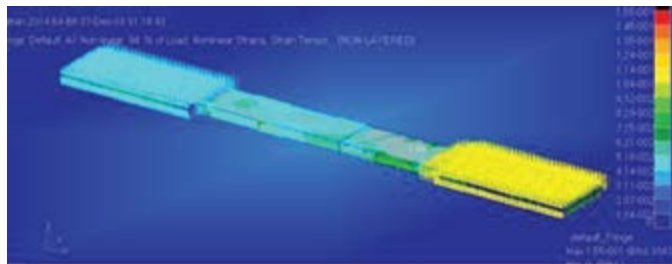

(b)

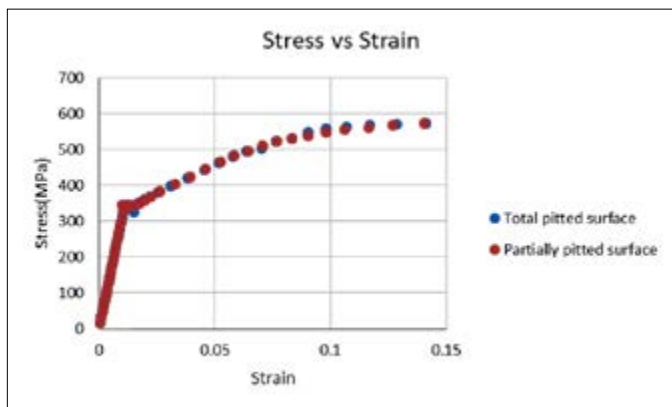

(c)

**Fig 13.** FEA of DOP 19 (a) Total pitted surface, b) Partially pitted surface, (c) output stress strain curve.

The simulations were conducted for both pitted surface and partially pitted surface with maximum pitted cross sectional area using material definition of class and local plate. The ultimate stresses are compiled in TABLE III and TABLE IV.

For both type of plate sizes with increasing number of pit intensity. It can be visible from both the table that, for a particular percentage of pitting occurs in a plate, their stress reached to nearly equal ultimate point irrespective of the plate size. Fig 14 to Fig 20 shows the superimpositions of the input and output curves.

**TABLE III.** COMPARISON BETWEEN ULTIMATE STRESSES OF PITTED SURFACE AND PARTIALLY PITTED SURFACE

ULTIMATE STRESS in MPa (Local Plate)					
Pit intensity	DOP 0 (intact plate)	DOP 19	DOP 51	DOP 73	DOP 90
Total pitted surface	634.24	580.8	514.9	590.59	478.5
Partially pitted surface	634.24	571.3	514.9	485.59	475.8

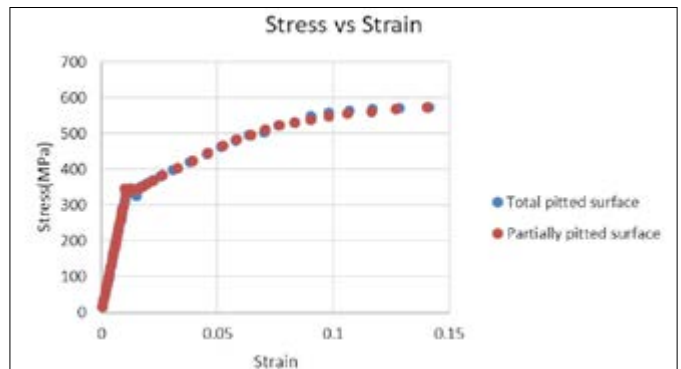

**Fig 14.** Comparison of total pitted surface and partially pitted surface with DOP 19 of local plate.

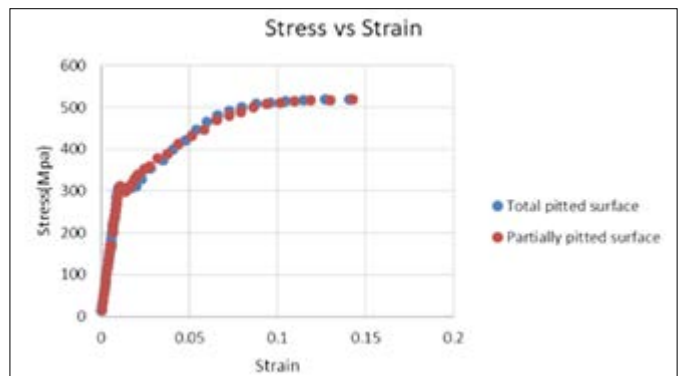

**Fig 15.** Comparison of total pitted surface and partially pitted surface with DOP 51 of local plate.

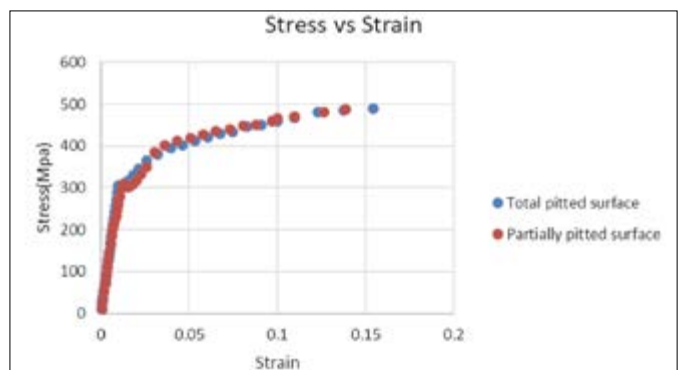

**Fig 16.** Comparison of total pitted surface and partially pitted surface with DOP 73 for local plate

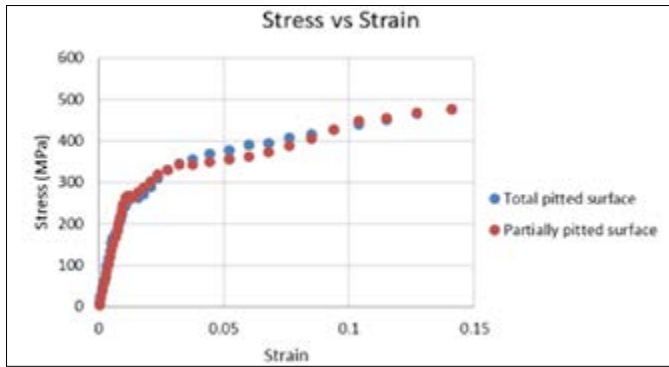

**Fig 17.** Comparison of total pitted surface and partially pitted surface with DOP 92 for local plate.

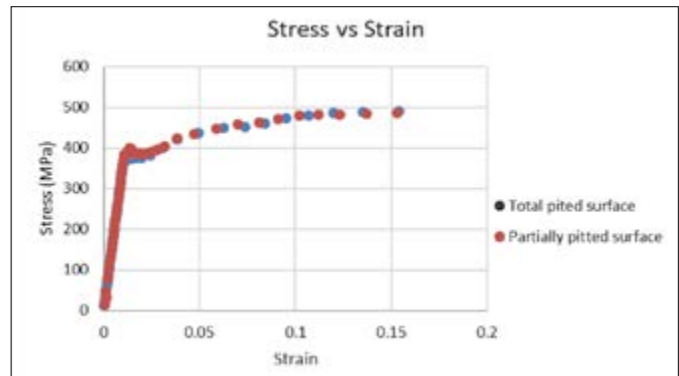

**Fig 20.** Comparison of total pitted surface and partially pitted surface with DOP 73 for class plate.

**TABLE IV. COMPARISON BETWEEN ULTIMATE STRESSES OF PITTED SURFACE AND PARTIALLY PITTED SURFACE.**

ULTIMATE STRESS in MPa (Class Plate)					
Pit intensity	DOP 0 (intact plate)	DOP 19	DOP 51	DOP 73	DOP 92
Total pitted surface	599.06	540.90	497.14	492.6	455.32
Partially pitted surface	599.06	541.2	497.14	485.58	452.08

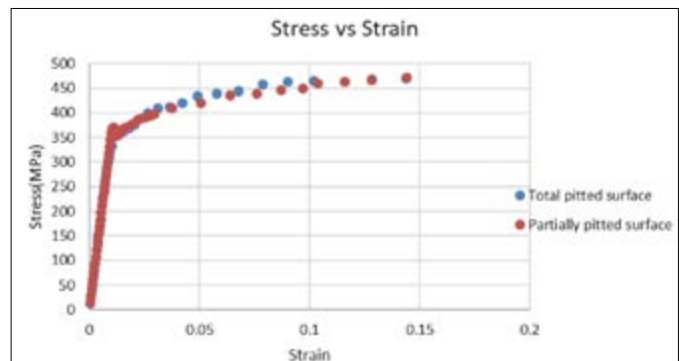

**Fig 21.** Comparison of total pitted surface and partially pitted surface DOP 92 for class plate.

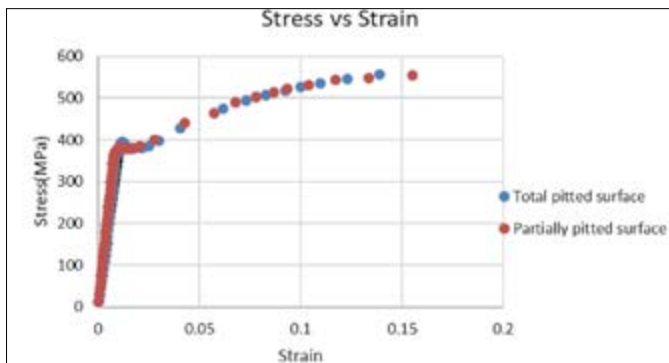

**Fig 18.** Comparison of total pitted surface and partially pitted surface with DOP 19 for class plate.

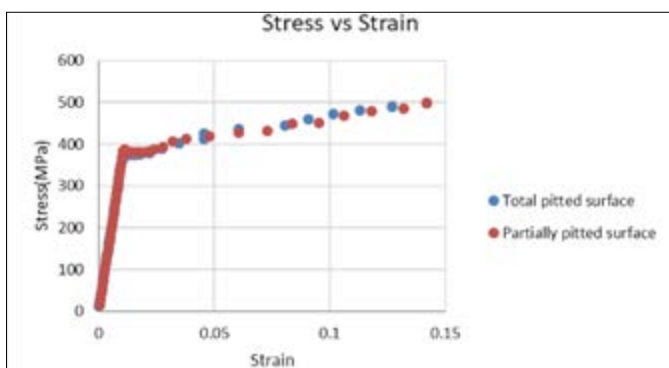

**Fig 19.** Comparison of full pitted surface and plate.

The finite element analysis results prove that partially pitted surface containing maximum pitted cross sectional area achieves the equal ultimate stress before necking as the total pitted surface does when they are subjected to equal amount of uniaxial tensile loads.

## 6.0 STRENGTH REDUCTION DUE TO PITTING

The effect of pits on one of the major parameters of structural integrity namely strength reduction been calculated from the simulation results. The stress at ultimate limit has been considered from the strain closest to ultimate strain of the flat plate which was determined from the flat plate simulation at known elongation (from experiment by UTM) of material.

Paik et al. [4] derived an empirical formula for predicting the ultimate compressive strength and shear strength based on minimum cross section of corroded surface considering cylindrical pit shape.

$$Ru = (1 - Dm) \cdot 73 \dots \dots \dots (1)$$



Where  $R_u$  is the ultimate strength of pitted plates normalized by that of an intact plate. Which is later on proved by Y Sumi and Ahmmed[6] that the formula is wide applicable in case of conical shape of pits under tensile load. The damage ( $D_m$ ) is defined by:

$$D_m = (A_o - AP) / A_o \tag{2}$$

Where  $A_o$  is the intact sectional area and  $AP$  is the smallest cross sectional area due to surface pits. However, in this study reduced strength was calculated from the data obtained from simulation and also using the empirical formula given by Paik et al [4] for both local and class plate taking into consideration of total pitted surface and partially pitted surface containing maximum pitted cross section (Table V, Table VI).

**TABLE V.** Comparison between  $R_u$  of Total Pitted Surface and Partially Pitted Surface (Local Plate)

DOP	$A_p$	$D_m$	$R_u$ (numerical data)	Calculation of $R_u$ from FE analysis	
				Total pitted surface	Total surface but partially pitted
19	63.65	0.16	0.88	.91	0.90
51	53.90	0.29	0.78	0.81	0.81
73	49.27	0.35	0.73	0.77	0.76
92	40.22	0.47	0.63	0.75	0.75

**TABLE VI.** Comparison between  $R_u$  of total pitted surface and partially pitted surface (class plate)

DOP	$A_p$	$D_m$	$R_u$ (numerical data)	Calculation of $R_u$ from FE analysis	
				Total pitted surface	Total surface but partially pitted
19	63.65	0.16	0.88	0.90	0.90
51	53.90	0.29	0.78	0.83	0.83
73	49.27	0.35	0.73	0.82	0.81
92	40.22	0.47	0.63	0.76	0.75

Fig 22 and fig 23 finally shows that strength is reducing in the same pattern for both the pitted surface and partially pitted surface containing maximum pitted cross section. Not only that, they are also nearly equal in magnitude with a variation not more than 6% from the empirical formula.

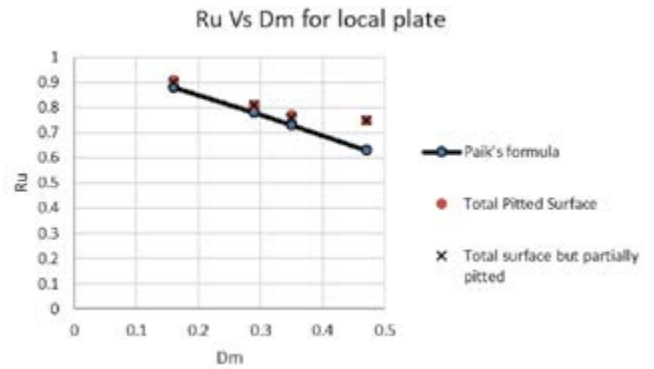

**Fig 22.** Comparison between strength reduction determined from analysis result and numerical data.

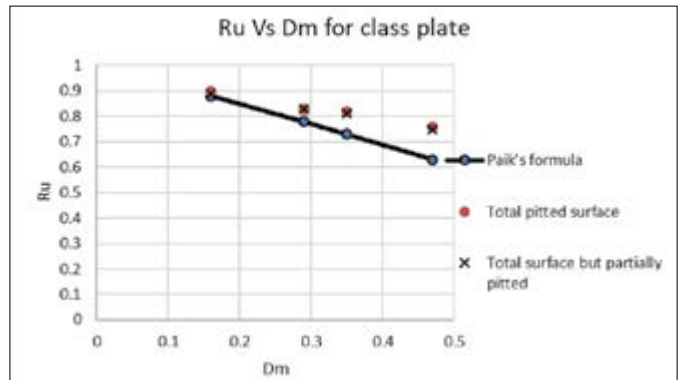

**Fig 23.** Comparison between strength reduction determined from analysis result and numerical data.

## 7.0 DISCUSSION

The marine structures are continuously subjected to corrosive environment during their service. It would be helpful if the characteristics of pitting can be predicted earlier through the survey of the vessels and other marine structures for assessing their condition. The study was conducted emphasizing on the effect of maximum pitted cross sectional area on aged marine plate which is subjected to uniaxial tensile loading. From this study, it has been understood that strength reduces and damage increases with increase of degree of pit depth irrespective of their pitting position. The graphical representation shows that Strength reduction factor of total pitted surface and surface containing maximum pitted cross section (partially pitted surface), being analogous in nature and pattern with increase of damage. From this, it can be decided that, only maximum pitted cross section is playing the major role in strength reduction and this proves the nullifying effect of the other cross sections.

## 8.0 CONCLUSION

During the survey it is essential to examine and inspect the condition of the structures which are subjected to pitting corrosion. This study is focused on the effect of the maximum pitted cross sectional area which is the primary influencing parameter of the strength reduction and the finite element analysis results confirm the null effect of pitted cross sections other than the maximum pitted cross section.

It can be concluded that, concentrating only on that cross section during survey of pitted surface is fair enough to assess the structural integrity of the marine aged structures. This will help the ship owner and the classification society to perform a better planning for the inspection and prediction of the consequent damage of the structure.

## References

- [1] Sumi Y, Strength and Deformability of Corroded Steel Plates Estimated by Replicated Specimens (Journal of Ship Production, 24(3), 2008), pp.161-167.
- [2] Nakai T, Matsushita H, Yamamoto N and Arai H, Effect of Pitting Corrosion on Local Strength of Hold Frames of Bulk Carriers (1st report) (Marine Structures, 17, 2004), pp.403-432.
- [3] Oka M, Kitada H & Watanabe T : Experimental study on statistical strength of corrosive mild steel, Journal of the Japan Society of Naval Architects and Ocean Engineers, 167, 1990, pp.229-235 (in Japanese).
- [4] Paik J K, Lee J M and Ko M J, Ultimate Strength of Plate Elements with Pit Corrosion Wastage (J Engineering for Maritime Environment, Vol.217, 2003), pp.185-200.
- [5] Paik, J K, Lee J M & Ko M J: Ultimate shear strength of plate elements with pit corrosion wastage, Thin-Wall Structures, 42, 2004, pp.1161-1176.
- [6] Ahmmad Md. M and Sumi Y, Strength and Deformability of Corroded Steel Plates under Quasi-static Tensile Load (J Mar Sci Technol, Vol.15(1), 2010), pp.1-15.
- [7] Islam M. R. and Sumi, Geometrical Effects of Pitting Corrosion on Strength and Deformability of Steel Rectangular Plates Subjected to Uniaxial Tension and Pure Bending (jjasnaoe,14, 2011, 9).
- [8] Yamamoto N and Ikegami K, A Study on the Degradation of Coating and Corrosion of Ships Hull Based on The Probabilistic Approach (Journal of Offshore Mechanics and Arctic Engineering 120, 1998), pp.121-128.
- [9] Islam M. R., PHD thesis titled Geometrical Effects Of Pitting Corrosion On Strength And Deformability Of Steel Plate Subjected To Tensile Load And Bending, 2011 .
- [10] Robert McNeel and Associates, Rhinoceros user guide: NURBS modeling for Windows. Version 3.0 (McNeel, Seattle, 2003).
- [11] Combined Documentation, MD Patran Users Guide (MSC. Software Corporation, Santa Ana, California, 2006 R

# BEHAVIOR OF CONCRETE FILLED STAINLESS STEEL TUBULAR COLUMN UNDER AXIAL LOADS

Lieutenant Colonel Muhammad Sanaullah<sup>(1)</sup>, Jesika Rahman<sup>(2)</sup>, Ibriju Ibrahim<sup>(3)</sup>  
and Major Md. Soebur Rahman<sup>(4)</sup>

1. General Staff Officer-Grade-1 (Research), Military Institute of Science and Technology  
Mirpur Cantonment, Dhaka-1216, Bangladesh  
E-mail: mssanaul35@gmail.com
2. Lecturer, CE Department, Military Institute of Science and Technology  
Mirpur Cantonment, Dhaka-1216, Bangladesh E-mail: jesikarahman547@ce.mist.ac.bd
3. Research Assistant, CE Department, Military Institute of Science and Technology  
Mirpur Cantonment, Dhaka-1216, Bangladesh E-mail: Ibrijuibrahim@gmail.com
4. Instructor Class-“A”, CE Department, Military Institute of Science and Technology  
E-mail: soeburrahman@gmail.com

## ABSTRACT

Concrete filled stainless steel tube (CFSST) is a composite structure that comprises both the structural steel and core concrete. A CFSST column has gained prominence from structural engineers all over the world as it provides sufficient strength and durability to withstand compressive loads. Use of stainless steel in place of mild steel provides the desired fire and corrosion resistance, as well as aesthetics otherwise a concrete filled steel tube (CFST) would be unable to. Due to its superior fire and corrosion resistance, stainless steels are used as a structural member in various constructions. This paper presents a detailed experimental and numerical study on the compressive behavior of concrete filled stainless steel tubular columns subjected to concentric loading. Hollow stainless tubes are also studied for comparison. Numerical models are developed using general purpose finite element (FE) software ABAQUS and have been validated using the experimental data of the present study as well as recently published test results. The FE models predict the experimental load-deformation behavior, ultimate strength and failure modes with good accuracy. Once the FE model is validated, the numerical results are compared with the existing conventional carbon steel design code/guidelines and developed a prediction formula for CFSST columns.

**Key words:** Stainless Steel, Concrete Filled Tube, Finite Element Modeling, Composite Structure

## 1.0 INTRODUCTION

The use of composite structures dates back to the eighteenth century in the United States<sup>1</sup>. A composite structural member comprising both structural steel and core concrete has gained tremendous popularity worldwide due to increased strength and larger usable space. The Concrete Filled Stainless Steel Tube (CFSST) is a composite column where the steel tube, having a rectangular or circular cross-section, is infilled with normal or high strength concrete. The local inward buckling being reduced, the concrete fill inside adds confinement and compressive strength to the column<sup>2</sup>. It is because of the composite action of

steel and concrete that the CFSST column inhibits excellent seismic and fire resistance<sup>3,4</sup>. Moreover, the steel section behaves as the formwork and reduces the cost of labor in the construction phase.

Till date, many researchers have studied the performance of concrete filled carbon steel tubular (CFST) columns<sup>5,6,7</sup> whereas research on CFSST columns is still in its early stages. Schneider and Huang et al. concluded that circular steel sections in a CFST provide greater post-yield axial ductility than other sections, namely square and rectangular<sup>8,9</sup>. The applicability of various codes to determine the strength of CFST columns has been reported

by researchers<sup>10</sup>. Previously, moment-curvature response of square CFSST columns was analysed and reported<sup>11</sup>. Researchers also reviewed the performance of CFSST in columns and joints as well as in bridges<sup>12</sup>. The excellent potential of stainless steels in bridge construction has been investigated by researchers in the past<sup>13</sup>. Numerical analysis is one of the most popular techniques to study and predict the behavior of CFSST sections. Number of studies in the past is done on square CFSST stub columns and thin-walled stiffened stub columns both numerically and experimentally<sup>14,15,16</sup>. However, no sufficient practical data yet exists to regulate a design guideline in order to make a CFSST compression member suitable for structural purposes. Hence, the paramount objective of the study is to gauge the behavior of CFSST columns under concentric axial loads by evaluating the results from property variations like concrete compressive strength and geometry of the steel sections. Upon the succession of which, it will be possible to select a reliable design guideline that allows the use of CFSST columns in wider implementations.

In this study, a total of ten CFSST short columns were tested to investigate their performance under compressive axial load. Five hollow stainless steel tubes are also included for comparison. Their performance due to changes in concrete compressive strength and steel section geometry were evaluated in terms of several tests carried out as described in the sections below. A nonlinear FE model was developed to simulate the compressive loading conditions on the column specimens. The results obtained from the model as well as that from a published literature were verified against the experimental results. In the final outset, two of the extensively used design codes, AISC and Eurocode 4 (EC4), were selected to predict the CFSST column strength which was then compared with the strength obtained experimentally and numerically.

## 2.0 EXPERIMENTAL PROGRAM

An experimental investigation was conducted to assess the compressive response, failure mode and load carrying capacity of CFSST columns. The test specimens were divided into five groups. Three types of cross-sections were included in the test series namely square, rectangular and circular hollow sections. For the comparison of performances, three

short column tests were carried out for each sections – two concrete filled specimens with concrete strengths of 30 MPa and 40 MPa and one hollow stainless tube.

### 2.1 Test specimen

Hollow stainless steel tubes were cold-formed sections cut in accordance with the required dimensions. Materials, available commercially, were used in the production of the concrete along with normal mixing and curing techniques. Stainless steel sections of Grade 203 was used in this study. Coupon test for the tensile properties of the stainless steel and cylinder test for the compressive strength of the concrete were carried out to monitor the strength of the constituent materials. Table 1 represents the dimensions of the specimens and material properties of concrete and stainless steel, where  $D$  is the depth of the square and rectangular sections and diameter for the circular sections, respectively.  $B$ ,  $t$  and  $h$  represent the width, thickness of the plate section and height of the specimens respectively.  $E_c$  and  $E_s$  are the modulus of elasticity of concrete and stainless steel,  $f'_c$  is the compressive strength and  $\nu$  is the Poisson's ratio of the concrete,  $\sigma_{0.2}$  and  $\sigma_u$  are the 0.2% proof stress and ultimate tensile strength respectively and  $n$  is strain hardening exponent of the stainless steel section.



**Table 1.** Measured specimen dimension and material properties

Group Name	Specimens Designation	D X t X h (mm)	B (mm)	$f'_c$ (MPa)	$E_c$ (MPa)	$\sigma_{0.2}$ (MPa)	E0 (GPa)	n
G1	S1H	63.5 X 1.5 X 190.5	63.5	-	-	470	198	3.5
	S1C30			30	25743	470	198	3.5
	S1C40			40	29725	470	198	3.5
G2	S2H	76.2 X 1.5 X 228.6	50.8	-	-	470	198	3.5
	S2C30			30	25743	470	198	3.5
	S2C40			40	29725	470	198	3.5
G3	S3H	76.2 X 1.5 X 228.6	76.2	-	-	470	198	3.5
	S3C30			30	25743	470	198	3.5
	S3C40			40	29725	470	198	3.5
G4	S4H	101.6 X 1.5 X 304.8	50.8	-	-	470	198	3.5
	S430			30	25743	470	198	3.5
	S4C40			40	29725	470	198	3.5
G5	S5H	101.6 X 1.5 X 304.8	-	-	-	470	198	3.5
	S5C30			30	25743	470	198	3.5
	S5C40			40	29725	470	198	3.5

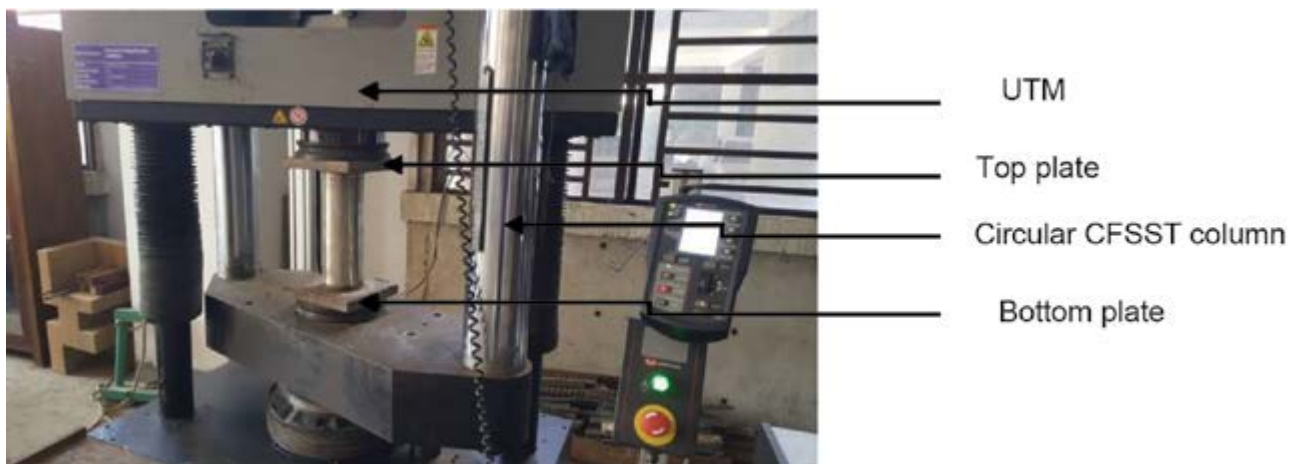
**Fig 1.** Experimental Set-up of CFSST Column

### 3.0 FINITE ELEMENT MODELLING

The general-purpose finite element program ABAQUS version 6.14 was used to build a nonlinear 3D FE model to investigate the behavior and strength of CFSST columns comprising the aforementioned variety in geometric and material properties. The stainless steel tube was modeled using four-node shell elements (S4R) and the concrete was modeled using 8 node brick elements (C3D8R). Surface-based interaction with a contact pressure model in the normal direction and a Coulomb friction model in the tangential directions was used to simulate contact between steel and core concrete. Although

there exists a cover of chemically stable chromium oxide for corrosion prevention of the stainless tube, the column's behavior is not sensitive to the selection of friction coefficient between steel and concrete. A coefficient of friction between the stainless tube and core concrete was therefore taken as 0.25 for the current study. The Poisson's ratio of steel and concrete were considered as 0.3 and 0.2, respectively. The damage plasticity model available in the ABAQUS package was used to model the concrete behavior. The modeling technique proposed in the previous study was used to model the concrete and stainless steel<sup>16</sup>. The technique proposed by another study was used to simulate the circular CFSST columns.

FE model of CFSST test specimens was developed. The load-deflection, as well as failure behavior obtained from the numerical simulation, were compared with that of the experimental results. All the column samples were designed to examine the behavior for concentric axial loading. A contrast between the experimental and numerical ultimate capacities of the samples are also presented in the following sections.

## **4.0 VALIDATION OF THE FINITE ELEMENT MODEL**

### **4.1 Current Experimental and Numerical Investigation**

FE model of CFSST test specimens was developed. The load-deflection, as well as failure behavior obtained from the numerical simulation, were compared with that of the experimental results. All the column samples were designed to examine the behavior for concentric axial loading. A contrast between the experimental and numerical ultimate capacities of the samples are also presented in the following sections.

#### **4.1.1 Load-Deflection Behaviour**

The maximum axial compressive load and corresponding strain, as determined from the numerical model are compared with that of the experimental data. The load-deflection behavior of the five groups of CFSST columns tested are illustrated in Figure 2 which shows that the FE simulation can predict the experimental results with good precision. From Table 2 it is seen that the circular sections exhibit greater capacity both experimentally and numerically. Also, the hollow sections in each group shows weaker strength compared to their counterparts. However, the peak load in G1 samples are found to vary by about 42% and 9% for the hollow and concrete filled sections respectively. The ratio of the experimental to numerical capacities,  $P_{exp}/P_{num}$  ranges from 0.93 to 1.11 and corresponding coefficient of variation (COV) of 0.06 which validates the numerical simulation further. Again, the ratio of the numerical to experimental average axial strain at peak load,  $\epsilon_{num}/\epsilon_{exp}$ , ranges from 0.940 to 1.07 and the corresponding COV of 0.09 is observed. Therefore, it is obvious that the FE model developed in this study is capable of predicting the ultimate capacity and corresponding peak strain of CFSST columns with very good accuracy.

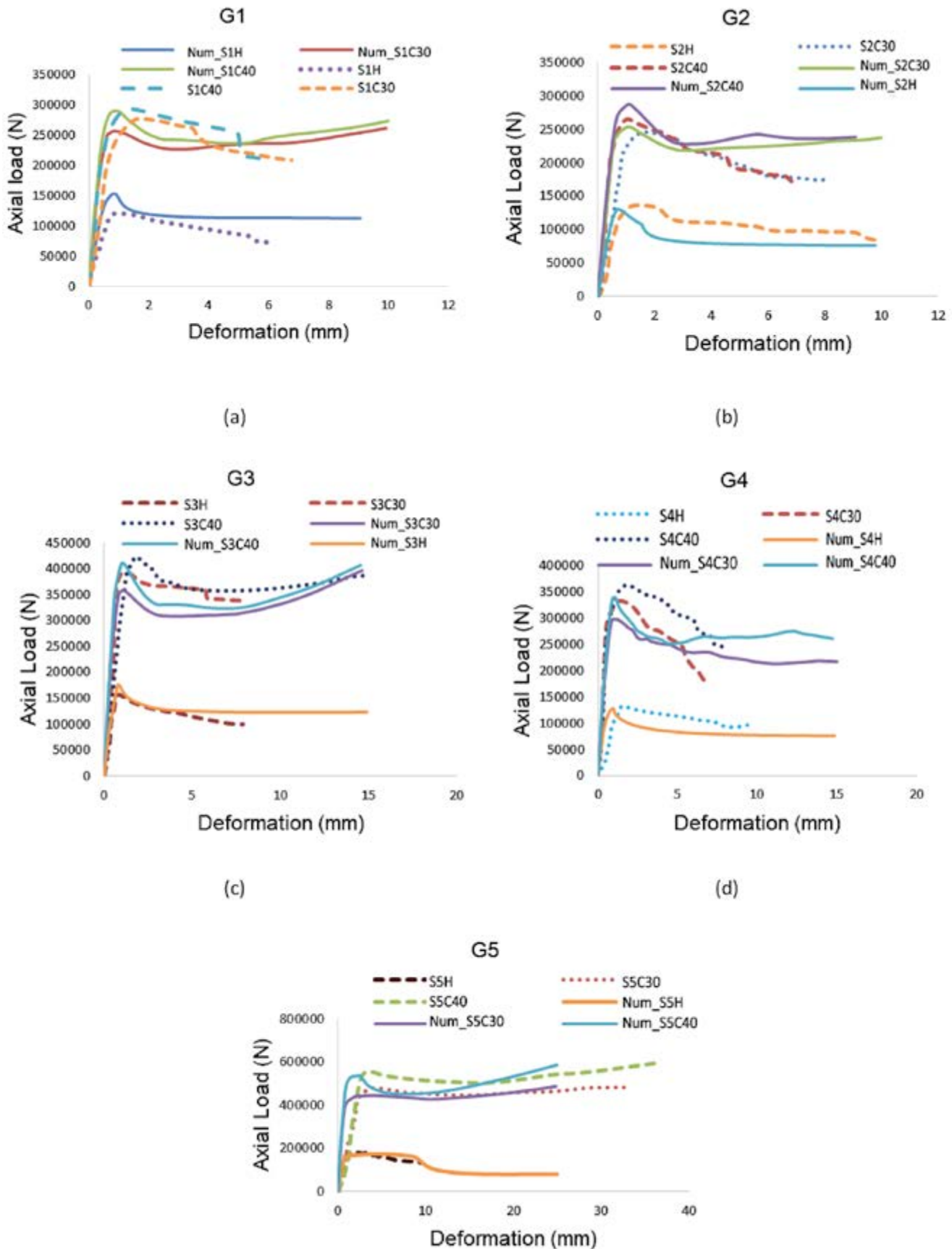

**Fig 2.** Experimental and Numerical Behaviour of CFSST Column Specimens

**Table 2.** Comparison between experimental and numerical analysis CFSST strengths

Group Name	Specimens Designation	Peak axial load		$\frac{P_{exp}}{P_{num}}$	Axial Strain at Peak Load		
		$P_{exp}$ (kN)	$P_{num}$ (kN)		Experimental $\epsilon_{exp}(\mu\epsilon)$	Numerical $\epsilon_{num}(\mu\epsilon)$	$\frac{\epsilon_{exp}}{\epsilon_{num}}$
G1	S1H	137	126	1.09	5578	5526	1.01
	S1C30	276	257	1.07	5521	5517	1.00
	S1C40	293	289	1.01	6210	5935	1.05
G2	S2H	133	132	1.01	4181	4097	1.02
	S2C30	242	254	0.95	4824	4729	1.02
	S2C40	266	287	0.93	4773	4767	1.00
G3	S3H	158	171	0.93	4573	4486	1.02
	S3C30	391	358	1.09	4736	4809	0.98
	S3C40	413	411	1.01	4956	4989	0.99
G4	S4H	132	121	1.09	3345	3451	0.97
	S4C30	330	298	1.11	3465	3403	1.02
	S4C40	359	340	1.06	3561	3501	1.02
G5	S5H	177	173	1.02	11429	12802	0.89
	S5C30	478	444	1.08	12685	13201	0.96
	S5C40	552	535	1.03	12278	9250	1.33
		Mean		1.03	Mean		1.02
		COV		0.06	COV		0.09

#### 4.1.2 Failure Modes

Comparison between the failure modes obtained from the FE analysis and that of the experimental observation from the current study were made. Photographed images of failure modes of the specimens under concentric axial load were used to serve the purpose. It was observed that the failure pattern varied mostly due to changes in cross-section and slightly due to a change in concrete strength. The main failure was at the corner due to bulging out of concrete in rectangular columns filled with

concrete. However, for circular sections, the main failure was due to buckling. Concrete crushing prevailed the yielding of the stainless steel during the experiment. A good resemblance in failure pattern was found in the developed FE model for the same loads applied. The typical failure behavior under the axial compressive load are highlighted in Figure 3. The failure pattern predicted by the model presented in the study resembled quite well to that of the observed experimentally adding more to the proof of accuracy of the numerical model.



(a) Square CFSST Column



(b) Circular CFSST Column

**Fig 3.** Failure modes observed from experimental results



**Table 3.** Geometrical and material properties of the specimens<sup>16</sup>

Sl No.	Specimens Designation	BxTxL (mm)	Properties of Concrete			Properties of Stainless Steel		
			E <sub>c</sub> (MPa)	f <sub>c</sub> ' (MPa)	v	E <sub>0</sub> (MPa)	σ <sub>0.2</sub> (MPa)	n
1	S20-50x3-A	51x2.85x150	21795	21.5	0.2	207900	440	8.2
2	S20-100x5-A	101x5.05x300	21795	21.5	0.2	202100	435	7
3	S30-100x3-A	101x2.85x300	27765	34.9	0.2	195700	358	8.3
4	S30-150x3A	152x2.85x450	27765	34.9	0.2	192600	268	6.8
5	SHS1C40	150.5x5.83x450	32084	46.6	0.2	194000	497	3
6	SHS-5-C60	100x4.9x300	34216	53	0.2	180000	458	3.7

**Table 4:** Comparison between the experimental capacity of specimens<sup>16</sup> and numerical capacity (current study)

Sl No.	Specimens Designation	f <sub>c</sub> ' (MPa)	Peak axial load			Axial Strain at Peak Load		
			P <sub>exp</sub> (kN)	P <sub>num</sub> (kN)	P <sub>exp</sub> /P <sub>num</sub>	ε <sub>exp</sub> (με)	ε <sub>num</sub> (με)	ε <sub>exp</sub> /ε <sub>num</sub>
1	S20-50x3-A	21.5	363	378	0.96	10000	10300	0.97
2	S20-100x5-A	21.5	1360	1290	1.05	9800	9500	1.02
3	S30-100x3-A	34.9	764	791	1.06	4630	4900	1.02
4	S30-150x3-A	34.9	1178	1203	0.98	3700	4000	0.93
5	SHS1C40	46.6	2745	3029	0.91	10000	10000	1.00
6	SHS-5-C60	53	1565	1499	1.04	7700	8300	0.93
				Mean	0.99			0.98
				COV	0.06			0.04

Figure 4 represents the numerical capacities predicted by the model as well as experimental capacities of the published study<sup>16</sup> and the numerical capacity as predicted by the model generated in this study. Close agreement in the results is observed between the published and the current models, respectively.

## 5.0 COMPARISON BETWEEN CODE PREDICTIONS AND NUMERICAL RESULTS

### 5.1 Existing Design Codes of Practice

The axial strengths obtained from the test results as represented in this paper are compared with that of the codes practiced internationally for the design of steel-concrete composite members. Two such codes, the American Specification AISC-2015<sup>19</sup>, the Eurocode 4 (EC4)<sup>20</sup> are nominated for the subsequent study. The American Institute AISC specifies the same equation to determine the axial capacity for all composite compressive members irrespective of geometric varieties in steel sections. As supplied by the code, the Eq. (1) is used to determine the design axial capacity of the composite columns under

investigation.

$$P_{AISC} = 0.85A_c f'_c + A_s f_y \quad (1)$$

A<sub>c</sub> and A<sub>s</sub> are the cross-sectional areas of concrete and stainless steel respectively. The f<sub>c</sub>' is denoted as concrete compressive strength in MPa and f<sub>y</sub> as the yield strength of stainless steel in MPa taken equal to the 0.2% proof stress. On the other hand, EC4 specifies design regulations for all steel-concrete composite sections with or without reinforcement. The code provides equation to predict design strength for concrete filled tubular columns by taking concrete confinement into account. The specifications in this code is for conventional carbon steel tubes which are assumed to be the same for the stainless steel tubes. The ultimate capacities of concrete filled rectangular and square steel tubes (P<sub>EC4</sub>) are calculated by the simple summation of the design strengths of concrete and that of the steel comprised (Eq. 2) provided that the ratio of section width to thickness is less than or equal to 52ε where ε = (235/f<sub>y</sub>)<sup>0.5</sup>. The confinement factor, however, is only considered in calculating the capacity of concrete filled circular sections

( $P_{EC4\text{ circular}}$ ) as shown in Eq. (3).

$$P_{EC4} = A_c f'_c + A_s f_y \quad (2)$$

$$P_{EC4\text{ circular}} = A_s f_y \eta_2 + [A_c f'_c (1 + \eta_1 \frac{t}{D} \frac{f_y}{f'_c})] \quad (3)$$

Here,  $D$  represents the diameter of the circular steel section and the factors  $\eta_1$  and  $\eta_2$  are coefficients of confinement of concrete and steel respectively.

**Table 5.** Comparison of the strength determined from numerical analysis and design standards.

Group Name	Specimens Designation	Pnum (kN)	PEC4 (kN)	PAISC (kN)	Comparison	
					$P_{num}/P_{EC4}$	$P_{num}/P_{AISC}$
G1	S1H	126	138.8	88.8	0.91	1.42
	S1C30	257	331.2	184.07	0.78	1.40
	S1C40	289	286.2	215.3	1.01	1.34
G2	S2H	132	111	88.8	1.19	1.49
	S2C30	254	186.4	180.1	1.36	1.41
	S2C40	287	197.9	210	1.45	1.37
G3	S3H	171	166.6	106.8	1.03	1.60
	S3C30	358	259.6	245.1	1.38	1.46
	S3C40	411	370.1	290.4	1.11	1.42
G4	S4H	121	111.1	106.8	1.09	1.13
	S430	298	177.9	229.1	1.68	1.30
	S4C40	340	191.4	269.1	1.78	1.26
G5	S5H	173	287.9	222.6	0.60	0.78
	S5C30	444	623.8	417.6	0.71	1.06
	S5C40	535	689.7	481.5	0.78	1.11
				Mean	1.12	1.30
				COV	0.31	0.16

## 5.2 Comparison with Code Predicted Strength

Table 5 represents the comparison between the axial capacity obtained from the current numerical investigation with the design capacity from AISC and EC4 codes as calculated from Eqs. (1), (2) and (3), respectively. For simplification in data representation, the design strengths by EC4 guidelines of circular columns in G5 are denoted as  $P_{EC4}$  in the table. It is seen that AISC is more conservative than EC4 predicting the design strength. This might be due to the fact that AISC does not take into account the

effect of confinement of the concrete core by the steel tube<sup>21</sup>. For instance, the design strength predicted by the AISC,  $P_{AISC}$ , for group G5 is 6% and 11% less than that predicted by the numerical load Pnum. Also, the Pnum is as high as 42% to 60% as PAISC for column samples in G3. The lesser conservative nature of prediction by EC4 can be observed in the table where the  $P_{num}$  is less than PEC4 by 22% to 40% in G5. Reasonable values are obtained when the mean and corresponding COV of  $P_{num}/P_{EC4}$  and  $P_{num}/P_{AISC}$  respectively, were compared.

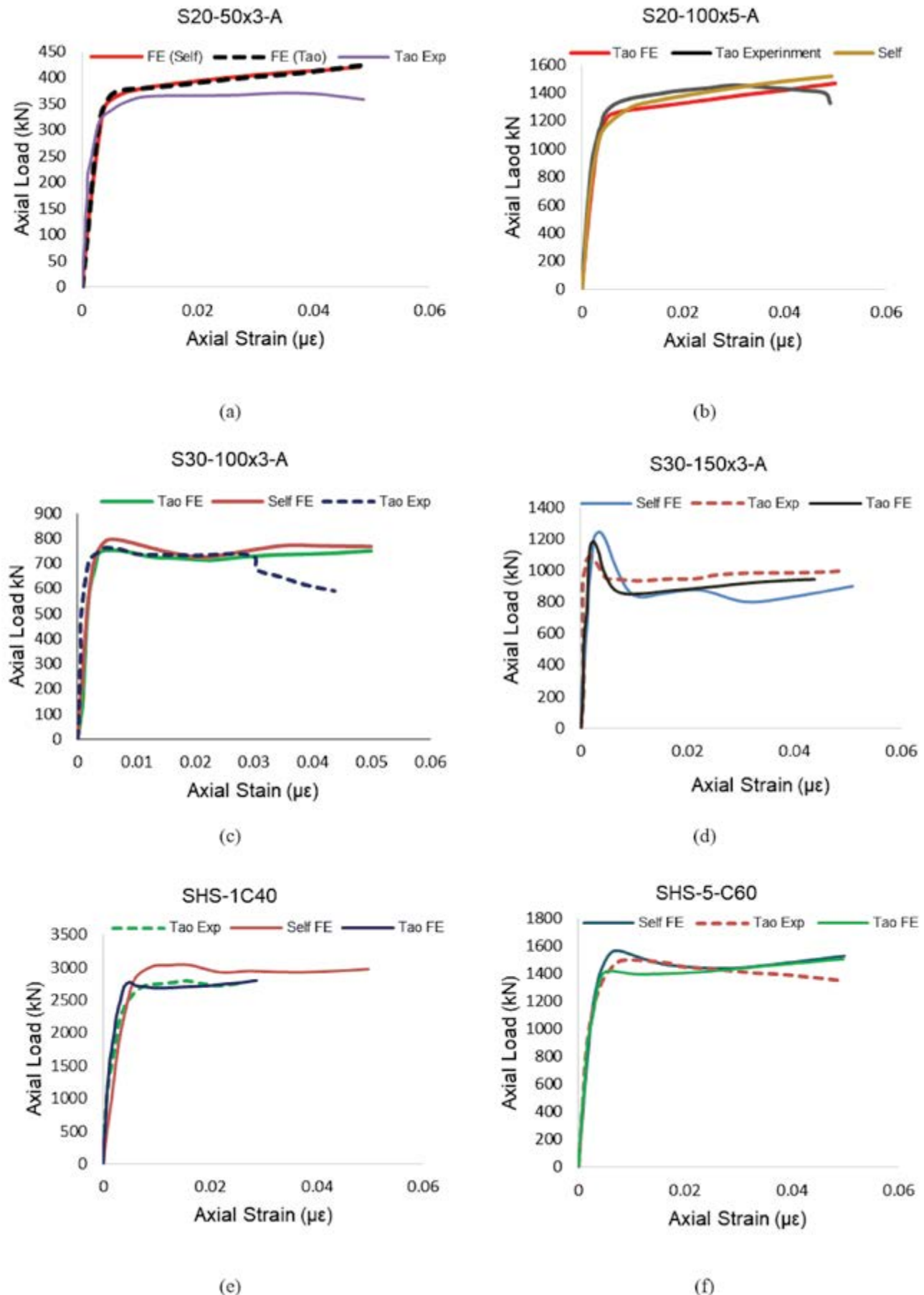

**Fig 4.** Comparison of the current FE analysis with the published FE analysis and experimental results<sup>16</sup>

## 6.0 CONCLUSIONS

Experimental study was carried out on fifteen CFSST short columns subjected to axial compressive loads. A nonlinear FE analysis was done in order to predict the behavior of the columns in the present study as well as the results published by previous researchers. The following conclusions can be deduced from this study:

- i. The numerical model can predict the behavior and load carrying capacity of CFSST columns under axial compressive loads with very good accuracy.
- ii. Keeping all other factors constant, increasing the strength of concrete from 30 MPa to 40 MPa increased the ultimate capacity of the columns by 15%.
- iii. The existing design codes for CFST columns are conservative in calculating the strength of CFSST columns. This is mainly due to the significant strain hardening of the cold-formed stainless steel tubes compared to its carbon steel counterpart.

## 7.0 ACKNOWLEDGEMENT

The authors would like to acknowledge STEELTECH for supplying the stainless steel specimens. The expert assistance by the technical staff in the Department of Civil Engineering at Military Institute of Science Technology is also appreciated.

## References

- [1] M. S. Rahman, M. Begum and R. Ahsan, Comparison between Experimental and Numerical Studies of Fully Encased Composite Columns, World Academy of Science, Engineering and Technology, International Journal of Structural and Construction Engineering, 10(6), (2016).
- [2] H. Hu, C. Huang, M. Wu and Y. Wu, Nonlinear Analysis of Axially Loaded Concrete-Filled Tube Columns with Confinement Effect. Journal of Structural Engineering, 129(10) pp. 1322-1329, (2003).
- [3] P. Chunhaviriyakul, G.A. MacRae, D. Anderson, C. G. Clifton and R. T. Leon, Suitability of CFT columns for New Zealand Moment Frames. New Zealand Society for Earthquake Engineering, 48(1), (2015).
- [4] Q. Tan, L. Gardner, L. Han and T. Song, Fire performance of steel reinforced concrete-filled stainless steel tubular (CFSST) columns with square cross-sections. Thin-Walled Structures, 143, (2019).
- [5] X.L. Zhao, L.H. Han, H. Lu, Concrete-filled Tubular Members and Connections. CRC Press, London, (2010).
- [6] K. Sakino, H. Nakahara, S. Morino and I. Nishiyama (2010). Behavior of Centrally Loaded Concrete-Filled Steel-Tube Short Columns. Journal of Structural Engineering, 130(2), (2004).
- [7] X.L. Elremali, and A. Azizinamini, (2010). Behavior and strength of circular concrete-filled tube columns. Journal of Constructional Steel Research 58 p. 1567–1591 (2002).
- [8] S.P. Schneider, Axially Loaded Concrete-Filled Steel Tubes. Journal of Structural Engineering, 124(10) pp. 1125-1138, (1998).
- [9] C.S. Huang, Y.K. Yeh, G. Y. Liu, K. C. Tsai, Y. T. Weng, S. H. Wang and M. H. Wu, Axial Load Behavior of Stiffened Concrete-Filled Steel Columns. Journal of Structural Engineering, 128(9) pp. 1222-1230, (2002).
- [10] Z. Tao, B. Uy, L. H. Han and S. H. He. Design of concrete-filled steel tubular members according to the Australian Standard AS 5100 model and calibration. Australian Journal of Structural Engineering 8(3) pp.197–214, (2008).
- [11] A. Roufegarinejad, B. Uy and M. A. Bradford. Behaviour and design of concrete filled steel columns utilizing stainless steel cross sections under combined actions. Australian Conference on the mechanics of Structures and materials, Perth, Australia, p. 159–65, (2004).
- [12] L. Han, C. Xu and Z. Tao. Structural uses of stainless steel — buildings and civil engineering. Journal of Constructional Steel Research, 152, p. 117–131 (2019).
- [13] G. Gedge Performance of concrete filled stainless steel tubular (CFSST) columns and joints: Summary of recent research. Journal of Constructional Steel Research, 64(11), p. 1194–1198 (2008).
- [14] E. Ellobody and B. Young, Design and behaviour of concrete-filled cold-formed stainless steel tube columns. Engineering Structures, 28(5) p. 716–28, (2006).
- [15] E. Ellobody Nonlinear behavior of concrete-filled stainless steel stiffened slender tube columns. Thin-Walled Structures, 45(3) p. 259–73 (2007).
- [16] Z. Tao, B. Uye, F. Liao and L. Han, Nonlinear analysis of concrete-filled square stainless steel stub columns under axial compression. Journal of Constructional Steel Research, 67 pp. 1719–1732, (2011).
- [17] Hibbitt, Karlsson and Sorensen, Inc (HKS). ABAQUS/Explicit User's Manual, Version 6.14, (2014).
- [18] Z. Tao, Z. Wang and Q. Yu, Finite element modelling of concrete-filled steel stub columns under axial compression. Journal of Constructional Steel Research, 89 pp. 121–131, (2013).
- [19] AISC, Load and resistance factor design specification for structural Steel buildings. AISC Specification, Chicago (IL USA), American Institute of Steel Construction, (2015).
- [20] Eurocode 4. Design of composite steel and concrete structures, part 1.1, general rules and rules for building. BS EN 1994-1-1: 2004. London (UK): British Standards Institution; (2004).
- [21] E. Ellobody, B. Young and D. Lam, Behaviour of normal and high strength concrete-filled compact steel tube circular stub columns. Journal of Constructional Steel Research, 62(7) pp. 706-715, (2006).



# ASSESSMENT OF FUTURE WATER DEMAND OF DHAKA CITY

**Lieutenant Colonel Md Ehsanul Haque**

Assistant Military Secretary, MS Br, AHQ, Dhaka Cantonment, Bangladesh

E-mail: ehsan\_army@yahoo.com

## ABSTRACT

Dhaka, the capital of Bangladesh, is one of the fastest growing cities of the world. It remains a great challenge to ensure uninterrupted water supply in the city with adequate quantity and quality round the year. Necessary measures are undertaken to meet the growing demand of water supply which is presently dependent on abstraction of groundwater. It appears that no further abstraction is feasible as the groundwater level is declining very fast. To reduce the overwhelming dependence on groundwater resources, surface water in the vicinity of the Dhaka city can be utilized. The study includes water demand and population projection upto 2035.

## 1.0 INTRODUCTION

Forecasting of water demand is a crucial component in the successful operation of water supply system. Accurately forecasted water demand either in short-term, or medium-term, or long-term time horizons can be very useful for capacity planning, preparation of maintenance, cost effectiveness and optimization of the operations of a water system. In addition, adequately forecasted water demand will be a basis for the strategically decision making on future water sources selection, improvement of the available water sources. Future water demand will also help in designing of the abstraction options so that water resources are not exhausted. All users in Dhaka have the right to access to available resources both surface water and ground water in near future. This chapter describes the existing progression of population and prediction of future water demand for Dhaka city. The estimation of future water demand addressing the uncertainties associated to the existing supply scenario and growth of population has been illustrated in the following sections.

## 2.0 PRESENT SITUATION OF GROUND-WATER DTWS IN DHAKA CITY

Over the years the number of DTWs has been increased enormously in Dhaka city. A graph showing the increasing number of DTWs is shown in Figure 1. At present 78% of the total supplied water is provided from 750 wells which were more than 88% before the introduction of Saidabad Phase II SWTP. Every year more numbers of new DTWs are installed to meet the increased demand of the city. Over the years, the increasing trend of DTW in Dhaka city is shown in Figure 1:

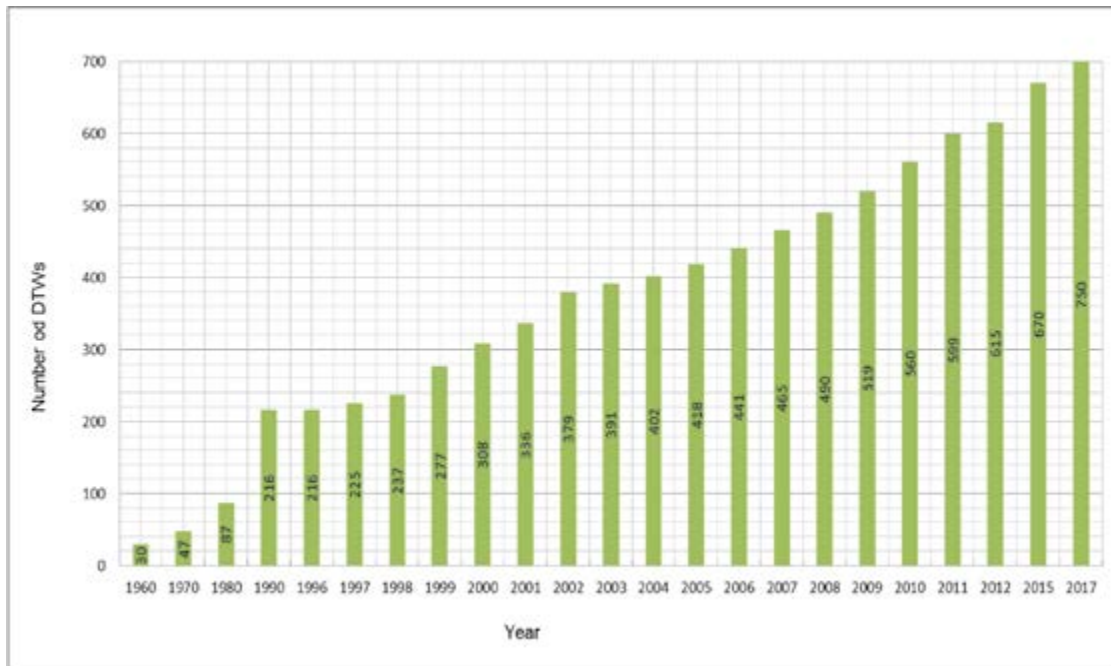

Fig 1. Increasing trend of DTWs over the years

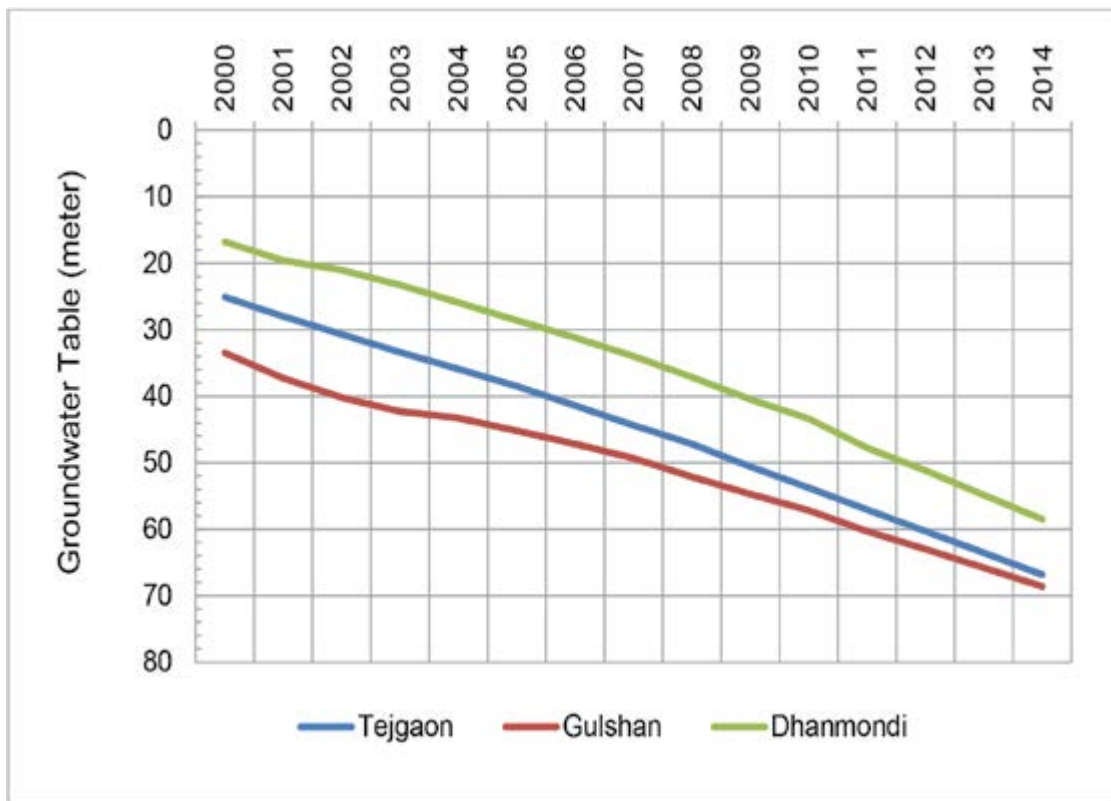
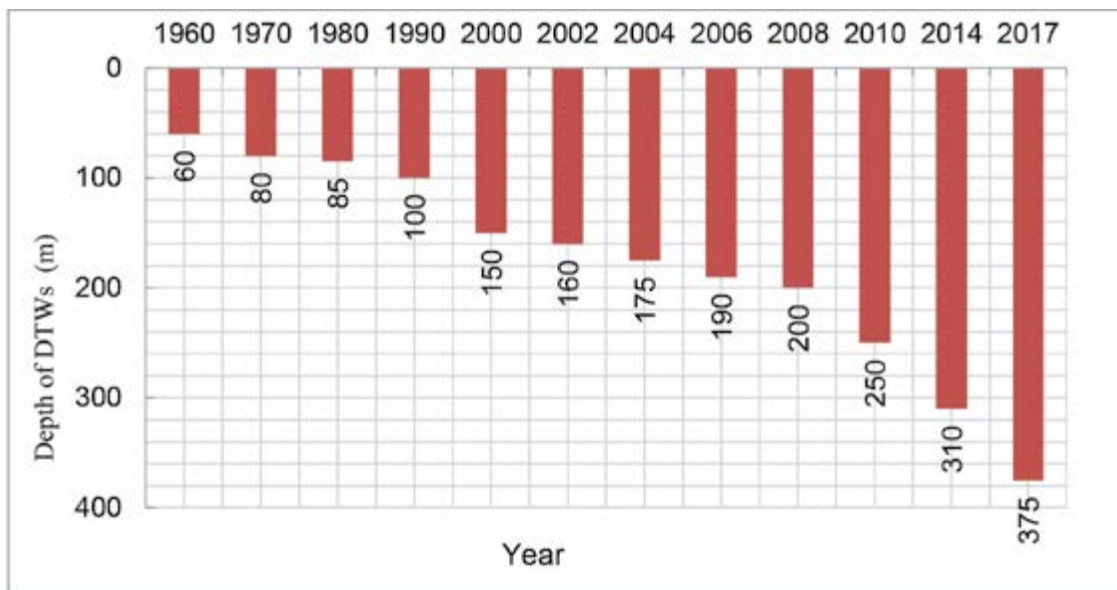

Fig 2. Groundwater depletion state in Tejgaon, Gulshan and Dhanmondi

The gradual mining depth of groundwater table for water extraction is shown at Figure 2. It was shown that mining depth for groundwater table is an increasing trend. For instance, in 2000 the depth was

20 m and in 2017 the depth reaches to 70 m. Some DTWs are used to extract water from a depth of 750 meters which is an alarming situation.



**Fig 3.** Gradual increase in mining depth of DTWS

Though it was found that, pumps operated more than 20 hours a day, most of the pumps are operating more than the recommended time. As a result, the aquifer is not getting minimum required time for recharging.

Again, the rate of groundwater depletion varies in different areas of the city. The rate of groundwater depletion in different areas of the city is shown at Table 1, Figure 2 and Figure 3.

**Table 1.** Groundwater depletion state in Lalbag, Motijheel, Cantonment, Mirpur, Tejgaon and Dhanmondi

Year	Groundwater depletion state in m						
	Mirpur	Lalbagh	Motijheel	Tejgaon	Gulshan	Cantonment	Dhanmondi
2000	29.9	27.0	38.8	25.1	33.5	20.8	16.8
2001	32.5	29.2	42.7	28.0	37.3	23.6	19.6
2002	35.4	32.3	45.5	30.7	40.2	27.0	21.0
2003	38.1	35.5	48.0	33.4	42.3	30.1	23.3
2004	41.2	39.0	50.6	35.9	43.3	32.9	25.9
2005	44.2	42.7	53.4	38.5	45.2	36.1	28.6
2006	47.3	46.3	56.5	41.4	57.2	39.0	31.2
2007	50.5	50.0	59.7	44.4	49.3	41.6	34.0
2008	53.75	53.7	62.6	47.2	52.1	44.5	37.1
2009	57.1	57.0	65.7	50.6	54.7	47.5	40.5
2010	60.5	60.3	68.8	53.8	57.2	50.8	43.4
2011	64.0	63.8	72.0	57.1	60.3	54.2	47.8
2012	67.4	67.0	75.0	60.3	63.0	57.5	51.2
2013	70.9	70.9	79.0	63.6	65.8	60.9	54.9
2017	74.3	73.5	83.0	66.8	68.6	64.2	58.5

(Source: DWASA 2014)

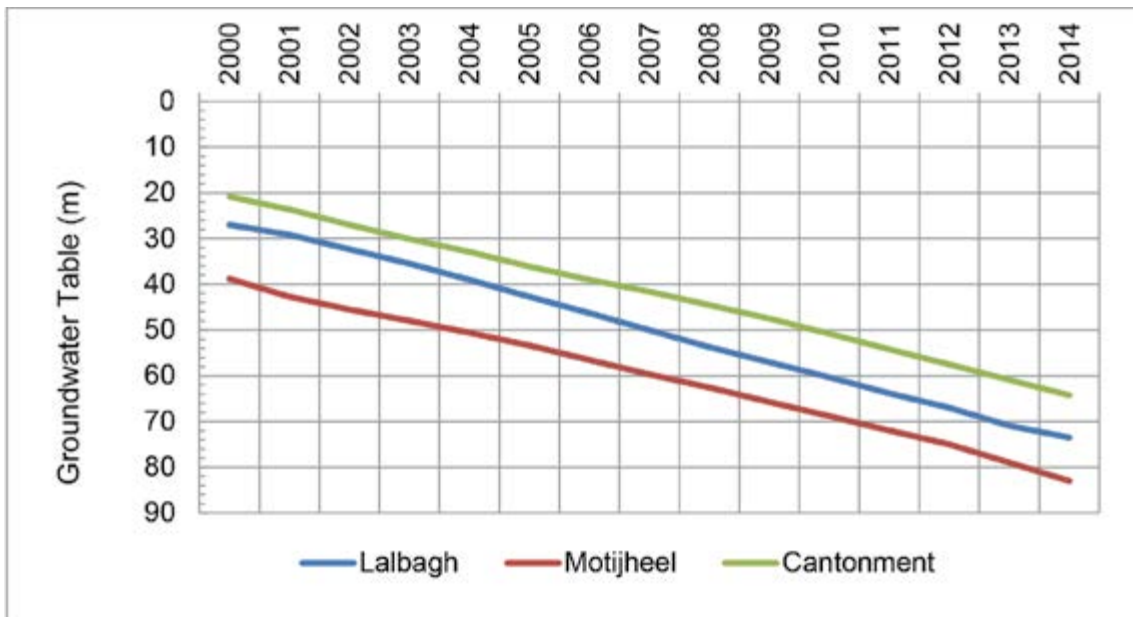

**Fig 4.** Groundwater depletion state in Lalbagh, Motijheel and Cantonment

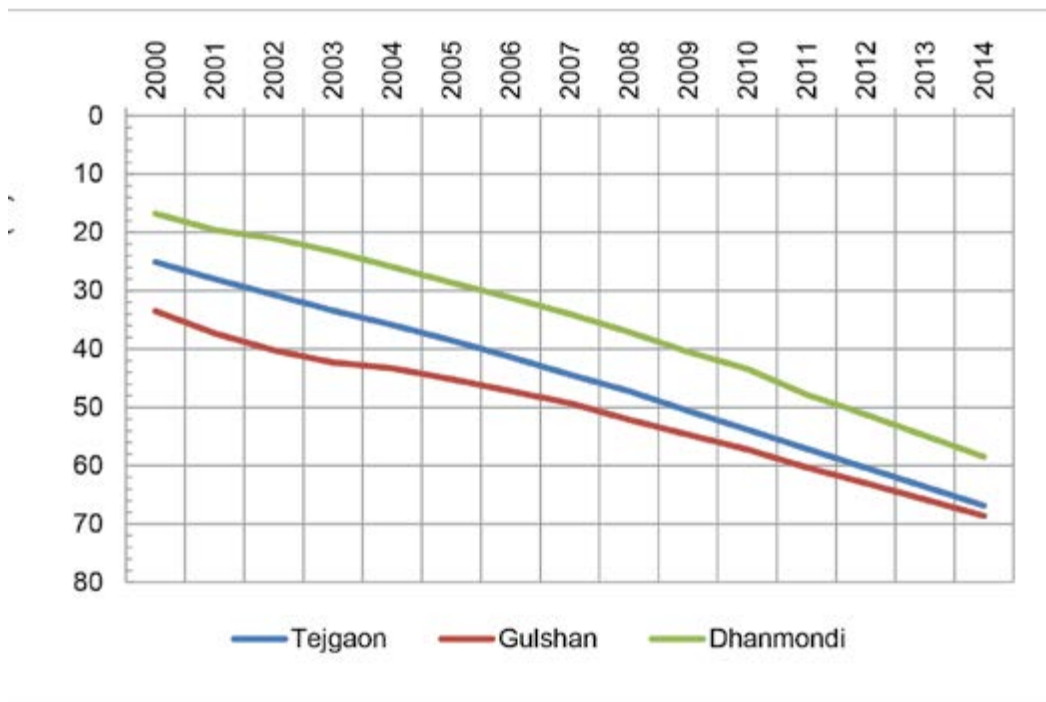

**Fig 5.** Groundwater depletion state in Tejgaon, Gulshan and Dhanmondi

Groundwater depletion is one of the prime causes of fresh water crisis which is directly related to over extraction triggered by increased demand of the city. Premature well failure is another challenge of DWASA which also affects the overall water production capacity. The expected life time of a pump is considered to be 30 to 40 years but every year 40 to 60 DTWs are being replaced just after an average life span of 2 to 3 years. Clogging due to over extraction and small particles from aquifer, poor

design and improper construction supervision are a few major causes of these premature well failures. SWTPs cannot produce at their optimum capacity due to non-availability of surface water. Surface water pollution is another cause of fresh water crisis of the city. Due to industrial waste, solid waste and sewage disposal the surface water of Dhaka City is getting exceedingly polluted. The pollution level has gone so high that in many cases the water is unusable in the SWTPs.

### 3.0 SURFACE WATER TREATMENT PLANTS (SWTP) OPERATED BY DWASA

In order to collect the information regarding the treatment capacity, production, quality parameter and cost effectiveness on the water supply situation numbers of visits have been conducted to existing SWTPs (Saidabad, Chadnighat, Godnail, Sonakanda) from 15 November to 25 November 2017. The officials informed that SWTPs cannot produce at their optimum capacity due to unavailability of raw surface water. Production capacity reduces more during dry season due to less flow of water.

For example, Chandnighat SWTP has a capacity of treating 39 MLD but produces only 3 MLD on an average during dry seasons due to low water level in Buriganga River. The use of chemicals for the treatment of raw surface water in these SWTPs is increasing significantly. It was also reported that if the intake water quality deteriorates more, it will not be possible to treat any more. As a result, due to increased demand and deteriorating water quality of peripheral rivers, supplying water from Padma and Meghna River is an utmost need. At present DWASA has 4 SWTPs with total production capacity are given at Table 2.

**Table 2.** Details of SWTPs

Serial	Name of SWTPs	Capacity (MLD)	Coverage Area
1.	Saidabad Water Treatment Plant (Phase 1 and 2)	450	Mods Zone 1, 2, 3, 4, 5, 6, 7
2.	Chadnighat (Dhaka) Water Works	39	Mods Zone 2, 3
3.	Narayanganj (Godnail) Water Works	33.17	Narayanganj west
4.	Sonakanda Water Works	1	Narayanganj east

(Source: DWASA 2017)

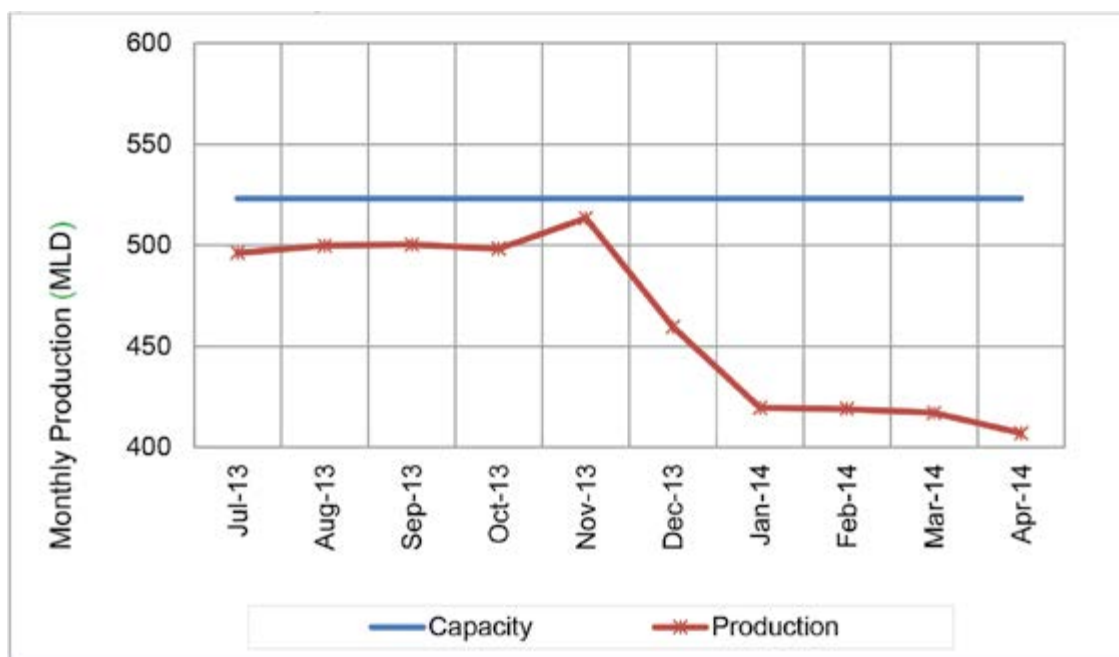

**Fig 6.** Seasonal variations in monthly production of SWTPs



### 4.0 WATER SUPPLY AS SURFACE WATER FROM RIVER SOURCES

In a personal communication of DWASA, was revealed that the actual fresh water production of DWASA is around 2196 MLD whereas the demand is more than 2300 MLD. It was revealed that the maximum production capacity of DWASA is 2486.47 MLD, but it can utilize 88.34% of maximum level due to various reasons discussed earlier. As a result, there is continuous shortage of 100 MLD or even more fresh water in wet season. This shortage becomes more during dry season stated in article. Around 80.56% of the supplied water of Dhaka comes from DTWs and rest 19.44% is obtained by treating surface water. Due to lowering of groundwater table neither it is possible to increase the rate of production nor is it feasible to dig more numbers of wells. All these conditions necessitate the requirements of exploring alternative options of water supply for meeting the present and future demand of the city.

### 5.0 POPULATION PROJECTION

The population data has been collected from Bangladesh Bureau of Statistics (BBS-2011) for the years 1975 to 2010. Best fit curve has been obtained and to be extrapolated for future prediction. These data has been plotted as shown in Figure 6.

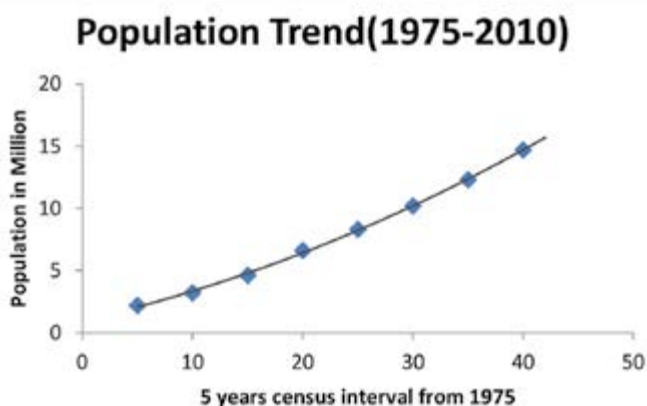

Fig 7. Population trend of Dhaka from 1975 to 2010

Based on the data and trend of graph the following equation was obtained

$$y=0.0035x^2+0.2011x+0.9768 \text{ ----- (1)}$$

Here in equation (1) y is the population in million and x is the census interval in 5 years. In order to estimation

and projection of future population a graph has been generated and obtained the population upto 2060 as shown in Table 3.

Table 3. Projected population upto 2060

Year	Projected Population in Million
2020	19.78
2025	22.62
2030	25.64
2035	28.84
2040	32.20
2045	35.75
2050	39.46
2055	43.36
2060	47.43

### 6.0 FUTURE WATER DEMAND ASSESSMENT

Future water demand has been calculated as per the population projection shown in Table 3. Water demand is divided into three main categories i, e, residential demand, non-residential demand and fire fighting requirement. System losses in water demand are also considered as percentage of these main categories.

#### 6.1 Residential Water Demand

The present area of Dhaka city is 404 sq km. In 2035 the area will be 617 sq km and in coming future it will be even more. The breakdown of indoor household water consumption was estimated from the survey conducted in the year 2012, 2014 and 2016 for sample size 50, 45 and 60 numbers of families respectively. The amount of water consumed per person for personal washing (showering, ablution and face/hand washing), clothes washing and floor washing seems to be logical in many cases as found from collected data. The residential consumption rate is considered 150 lpcd; non- residential (other) consumption is around 12%, fire fighting 5 lpcd and system loss is assumed as 8%. Breakdown of all possible water consumption as resulted from survey is shown in Table 4.

**Table 4.** Breakdown of indoor household water consumption

Feature	Collected Data in 2012		Collected Data in 2014		Collected Data in 2016	
	lpcd	%	lpcd	%	lpcd	%
Personal Washing	75	36%	70	45%	72	25%
Toilet Requirement	25	17%	30	20%	28	19%
Washing Apparatuses	26	16%	25	17%	24	13%
Clothes Washing	25	21%	17	13%	20	12%
Drinking	2	1%	2	2%	2	1%
Cooking	3		3	2%	4	18%
Floor washing	3	9%	2	1%	3	12%
Other Uses	1		1	0%	1	0%
Total	160	100%	150	100%	155	100%
Sample size	50		45		60	

(Source: DWASA 2014)

## 6.2 Non Residential Water Demand

Non-residential water consumptions such as consumptions in government/institutional, commercial, industrial and community buildings have been considered as a percentage 12% to 20% of total residential consumption.

## 6.3 Total Future Water Demand

Future demand assessment incorporates the key water demand factors such as population projection, per capita daily consumption and other residential and non-residential demands. The water requirement has been used to assess future demand for different scenarios upto 2035. The required production capacity was estimated for each of the scenarios based on different rates of system losses. The population has been projected based on previous inter-census growth rates and future urban development plans. Per capita daily consumption rates are based on the household survey findings for different structure types, possible reductions in poverty levels in the future, expected responses to tariff re-structuring and projections of changes in housing structure types. The proportion of non-residential (other) water demands has been based on urban development plans and possible composition of economic activities in Dhaka. The

different rates of system losses have been based on expected implementation of existing and new Dhaka service areas and assumptions on improved operation and maintenance of water supply infrastructures. It is expected that the projected water demands can be updated as part of regular census in expanded urban development plans. The extent of service area of Dhaka expanded to part of Tongi and Gachcha in the North West, Kaliganj in the north east, Rupganj in the west, Keranigonj in the south west and Bandar in the south east. Population density and existing and expanded Dhaka city is shown in Figure 7.

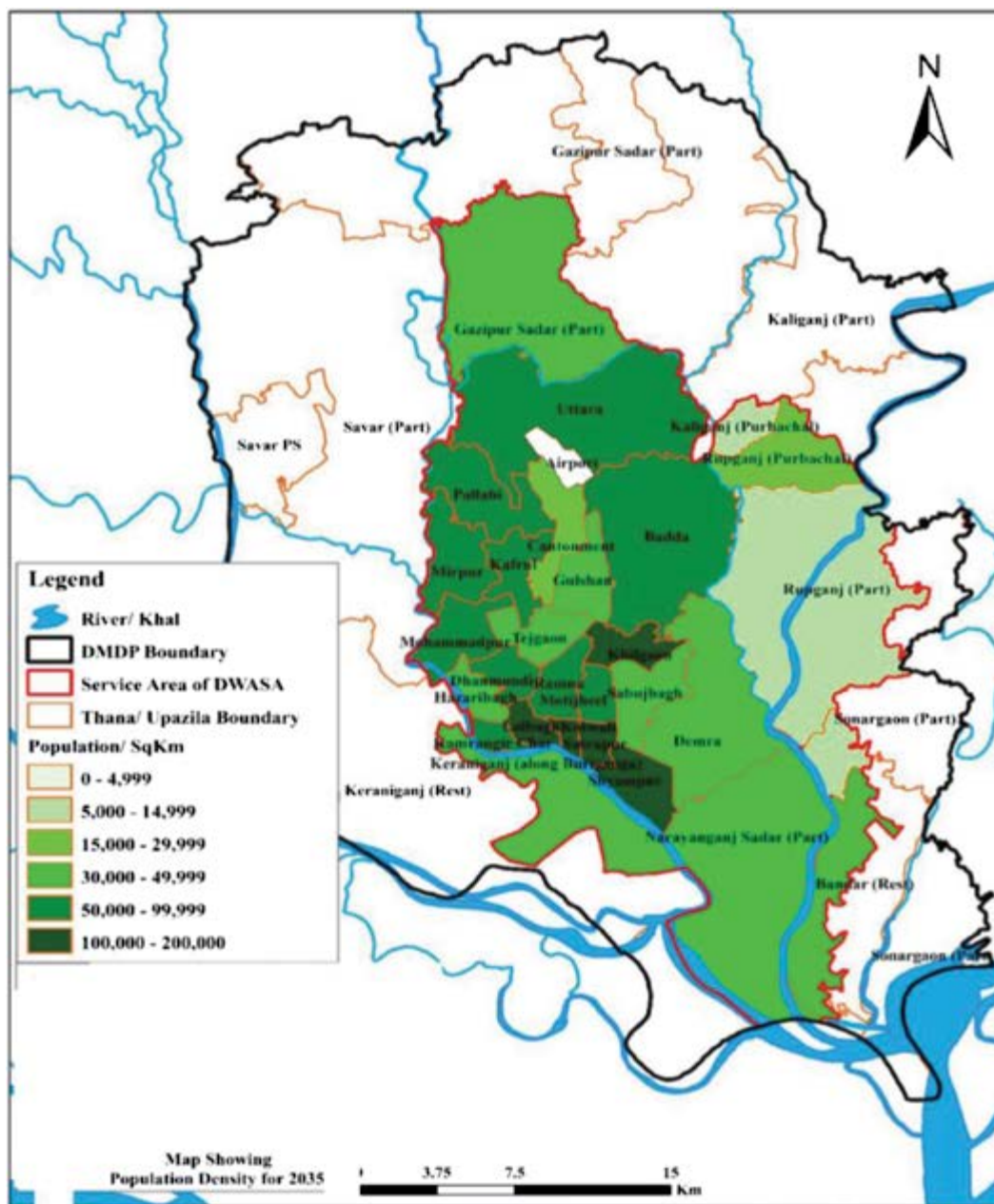

**Fig 8:**Map showing population density of Dhaka city

Notes:

- a. Initial residential consumption rate based on household demand survey
- b. Area expansion in 2020 includes Purbachal, Tongi, Gachcha and part of Keraniganj and Rugganj
- c. Area expansion in 2030 includes parts of Rugganj, Sonargaon and additional parts of Keraniganj.

A calculation was carried out to determine the future water demand of the city. In 2017 the estimated population is 18 million, residential consumption rate is 150 lpcd and considering other consumption, fire fighting, loss the total demand stands 2727 MLD. At present, 8% loss considered in the system where it is expected to improve further with the development of technology and infrastructure. Therefore, the gradual decrease of system loss upto 2% has been considered in this study. Likewise calculation upto

2035 year have been estimated and found around 5105 MLD can be seen in Table 5. The coverage area will increase with the time. The coverage area will be increased to 617 km<sup>2</sup> by 2025 km<sup>2</sup> and will be increased after the year 2045 to area upto 700 km<sup>2</sup> with more population and expansion of area (DWASA, 2016). A calculation has been made for the same scenario upto the year of 2060 and demand was estimated around 7091 MLD has been shown in Table 6.

**Table 5.** Estimation of projected water demand from 2017 upto 2035

<b>Year Item</b>	<b>2017</b>	<b>2020</b>	<b>2025</b>	<b>2030</b>	<b>2035</b>
Coverage Area (Sq km)	404	497	617	617	617
Estimated Population Served (Million)	18	19.78	22.62	25.64	28.84
Residential Consumption Rate (Lpcd)	150	150	150	150	150
Residential Consumption (MLD)	2250	2654.4	3059.1	3460.6	4009.2
Percentage of other Consumption (%)	12%	14%	16%	18%	20%
Other Consumption (MLD)	270	371.616	489.456	622.908	841.932
<b>Total Consumption (MLD)</b>	<b>2520</b>	<b>3026.016</b>	<b>3548.556</b>	<b>4083.508</b>	<b>4851.13</b>
Fire Fighting Requirement (MLD)	5	7	8	9	11
<b>Total Demand (MLD)</b>	<b>2525</b>	<b>3033.016</b>	<b>3556.556</b>	<b>4092.508</b>	<b>4862.13</b>
Percentage of Loss%	8%	7%	6%	5%	5%
Total Loss (MLD)	202.00	212.31	213.39	204.63	243.11
<b>Required Production Capacity (MLD)</b>	<b>2727.00</b>	<b>3245.33</b>	<b>3769.95</b>	<b>4297.13</b>	<b>5105.24</b>

**Table NB 6:** Estimation of projected water demand from 2040 upto 2060

<b>Year Item</b>	<b>2040</b>	<b>2045</b>	<b>2050</b>	<b>2055</b>	<b>2060</b>
Coverage Area (Sq km)	617	700	700	700	700
Estimated Population Served (Million)	32.20	35.75	39.46	43.36	47.43
Residential Consumption Rate (Lpcd)	150	150	150	150	150
Residential Consumption (MLD)	4291.25	4570.8	5048.4	5327.95	5594.6
Percentage of other Consumption	22%	21%	22%	23%	24%
Other Consumption	944.075	959.868	1110.65	1225.43	1342.7
<b>Total Consumption</b>	<b>5235.325</b>	<b>5530.67</b>	<b>6159.05</b>	<b>6553.378</b>	<b>6937.3</b>
Fire Fighting Requirement	12	12	12	14	15
<b>Total Demand</b>	<b>5247.325</b>	<b>5542.67</b>	<b>6171.05</b>	<b>6567.38</b>	<b>6952.3</b>
Percentage of Loss	4%	3%	3%	2%	2%
Total Loss	209.89	166.28	185.13	131.35	139.05
<b>Required Production Capacity</b>	<b>5457.22</b>	<b>5708.95</b>	<b>6356.18</b>	<b>6698.73</b>	<b>7091.3</b>

Final outcome of Table 1.6 is the total production capacity required for the Dhaka city which is 2727 MLD in 2017 and 5105 MLD in 2035. In the same process the demand will increase around 7091 MLD in 2060 which is very high compared to present population.

## 7.0 CONCLUSIONS

In this paper, prediction of future population and demand has been assessed to meet the future water requirement of Dhaka City. The causes of water crisis of the city are the rapid groundwater depletion, extreme surface water pollution and untreated surface water sources. It is apparent that present amount of water supply and its infrastructural arrangement are not sufficient to meet the future water requirement of the Dhaka city. There is a necessity to explore surface water sources to solve the water crisis. The Dhaka area is expected to expand from the current 404 km<sup>2</sup> to about 617 km<sup>2</sup> by 2035. During this period, the total population in the 617 sqkm area is expected to increase from 16 million in 2011 to 29 million by 2035. The total demand is expected to increase from about 1500 MLD in 2011 to 5105 MLD in 2035. Beyond 2035, there is likely to be around 50% increase in total demand by the year 2060. Water consumption in Dhaka city is showing a rising trend as the population and urban development are being expanded. This consequence needs due attention with proper estimation and evaluation of the surface water sources for future demand of Dhaka City.

## References

- [1] Dhaka Water Supply and Sewerage Authority (2014). Annual Report. Dhaka Water Supply and Sewerage Authority (July 2013 - June 2014).
- [2] Dhaka Water Supply and Sewerage Authority. (2014). Management Information Report. Dhaka: Global Information Department (April 2014).
- [3] Dhaka Water Supply and Sewerage Authority (2014). Water Supply Plan for Dhaka City: Draft Final Report. Dhaka: Dhaka Water Supply and Sewerage Authority.
- [4] Dhaka Water Supply and Sewerage Authority (2015). Annual Report. Dhaka Water Supply and Sewerage Authority (July 2014 - June 2015).
- [5] Dhaka Water Supply and Sewerage Authority. (2016). Water Supply Plan for Dhaka City: Draft Final Report. Dhaka: Dhaka Water Supply and Sewerage Authority.
- [6] Dhaka Water Supply and Sewerage Authority (2017). Water Supply Plan for Dhaka City: Draft Final Report. Dhaka: Dhaka Water Supply and Sewerage Authority.
- [7] Department of Environment, (2009). Report on water quality of selected rivers in Bangladesh for 1990-91 and Pollution Trend since 1984, Ministry of Environment and Forest, Government of Bangladesh.
- [8] Environmental Monitoring Report, (April, 2016). DOE (Department of Environment) Retrieved from <http://www.doe.gov.bd>.
- [9] Department of Public Health Engineering (2010), Retrieved from <https://www.dphe.gov.bd>.



# ACCOUNTING INFORMATION SYSTEM (AIS) PRACTICES AND ITS EFFECTS ON SMES: THE BANGLADESH HANDLOOM INDUSTRY EXPERIENCE

**Md. Ismail Hossain<sup>(1)</sup> and Major Md. Ferdousur Rahman PhD<sup>(2)</sup>**

1. 33rd BCS (General Education) Cadre Officer & Lecturer, Department of Accounting  
Hasanpur Shahid Nazrul Govt. College, Daudkandi, Cumilla  
E-mail: ismail9087@gmail.com

2. Associate Professor (Accounting), Department of Sc & Hum  
Military Institute of Science & Technology (MIST), Mirpur Cantonment Dhaka-1216, Bangladesh  
E-mail: ferdaus806@gmail.com

## ABSTRACT

The study is aimed to identify the scenario of practicing the Accounting Information System (AIS) by Benarashi, Jamdani, Reshmi, Shari, Lungi and Gamcha producing Handloom industry of Bangladesh. A qualitative research design was employed and a non-probability sampling design in the form of a convenience sampling method was employed to gather the data. Data were drawn from both primary and secondary sources. Primary data was drawn from 30 small-scale Shari-Lungi producers, 5 each from Pabna, Sirajgonj, Tangail, Dhaka, Narayanganj, and Narshingdi of Bangladesh by administering semi-structured questionnaires through personal interviews. There are many perceived factors affecting their adoption of accounting information system practices and their effects on their business operations in the area. Among such factors include; lack of adequate knowledge and training, willful misconduct, and negligence from owners as well as controlling authority part. It is also revealed that, all levels of employees are ignorant about the use of Accounting Software; rather they try little to keep accounting records manually. It was also found that accounting illiteracy is the root cause of that. It was concluded that the lack of accounting knowledge and skills may in future threaten the financial steadiness of the Handloom Sector. In sustaining the sector, the findings recommends operators to undergo basic accounting training as well as Accounting Software training to acquire relevant knowledge and skills, employ qualified accounting information systems personnel and providing them with good motivational packages to ensure that their efficiency and morale is enhanced and, maintain strong internal control to check the practice of misappropriating funds in the business.

**Key words:** Accounting Information System (AIS), Small & Medium Enterprise (SME), Handloom Industries

## 1.0 INTRODUCTION

The Small and Medium Enterprises (SMEs) contribute a lot in overall economic development of a country, particularly for developing countries like Bangladesh. Since this sector is labor intensive with short gestation period, it is capable of increasing national income as well as rapid employment generation; achieving Millennium Development Goals (MDGs) especially eradication of extreme poverty and hunger, gender equality and women empowerment. In Bangladesh, there are about 69,902 SME enterprises employing approximately

1,937,809 workforces (SME Credit Policies & Programmes: Bangladesh Bank). Their annual turnover is about BDT 573,510 million per year. A major portion of government revenue in different forms like Income tax, VAT, Customs duty etc. comes from these sectors. Major products producing in the SME clusters of Bangladesh are of 12 in number, Handloom, power loom and pit loom industries' products are important one of them (Abedin M.J. The independent 29 October 2018). Handloom industry is the biggest handicraft industry of Bangladesh. It is the second largest source of rural employment after agriculture. This sector meets the 40% of

total demand of clothes, internally, in the country. A manpower of about 1.5 million weavers, dyers, hand spinners, embroiderers and allied artisans have been using their creative skills into more than 0.3185 million active looms which produce more than 687 million meters fabrics every year. Besides, it provides employment opportunities to a million rural people, 50% of which are female. Another half a million people are indirectly engaged in the industry. It contributes more than 12.27 billion taka annually to the national exchequer as value addition (BHB Annual Report 2017-18). Since the long past, the traditional handloom industry has been the largest industry in the rural area of Bangladesh, and the handloom products, such as moslin were well-known in Asia and Europe. Until the seventeenth century moslin, the finest quality of handloom cloth made of silk, was used as cloth for the emperors' family and nobles of the court, and it was a major export items in the early British period (1757-1947) (Bhattacharjee, D. and Khaled, M. 1969). But now, handloom industry faces many challenges. Against the backdrop, maintenance of proper records is a pre-requisite for the success of every business or enterprise with loom industries are not an exception. According to Jones (2012), accounting is important in that, it allow businesses or organizations to understand their financial perspective. In order to develop the loom enterprises properly, there is the need for them to adopt proper accounting practices. According to Goltz (2011), poor accounting is one of the top ten reasons why small-scale businesses fail. So, the aim of the study is to try to identify what is the real scenario of accounting information system practice and the effect of that on performance of Handloom industry of Bangladesh and provide some recommendations for practicing the Accounting Information System.

## 2.0 CONCEPTUAL FRAMEWORK

### 2.1 Concept of SME (Small & Medium Enterprise)

Small and medium-sized enterprises (SMEs) or small and medium-sized businesses (SMBs) are businesses whose personnel numbers fall below certain limits. The abbreviation "SME" is used by international organizations such as the World Bank, the European Union, the United Nations and the World Trade Organization (WTO). (Wikipedia 2005). The Organization for Economic Co-

operation and Development (OECD) states "Small and medium-sized enterprises (SMEs) are non-subsidiary, independent firms which employ less than a given number of employees. This number varies across countries. The most frequent upper limit designating an SME is 250 employees, as in the European Union. However, some countries set the limit at 200 employees, while the United States considers SMEs to include firms with fewer than 500 employees. Small firms are generally those with fewer than 50 employees, while micro-enterprises have at most 10, or in some cases 5, workers. Financial assets are also used to define SMEs. In the European Union, a new definition came into force on 1 January 2005 applying to all Community acts and funding programmes as well as in the field of State aid where SMEs can be granted higher intensity of national and regional aid than large companies. The new definition provides for an increase in the financial ceilings: the turnover of medium-sized enterprises (50-249 employees) should not exceed EUR 50 million; that of small enterprises (10-49 employees) should not exceed EUR 10 million while that of micro firms (less than 10 employees) should not exceed EUR 2 million. Alternatively, balance sheets for medium, small and micro enterprises should not exceed EUR 43 million, EUR 10 million and EUR 2 million, respectively". Ministry of Industry of Bangladesh and Bangladesh Bank define SME industry containing asset amounted from Tk. 50,000 to Tk 1,50,00,000 besides having employees 50 to 150. Bangladesh Bank identifies 132 sectors of SMEs in Bangladesh. Handloom industries sector is positioned at 5th in list and tribal pit loom is positioned in number 78. (<https://bb.org.bd/openpdf.php>). Handloom industry produce different kind of products like "Jamdani", "Benarasi", "Katan", "Tangail Sharee", "Handloom Cotton sharees", "Lungi", "Silk sharee", "Gamcha", Mosquito Nets", "Bed Sheet & Bed Coverm Sofa Cover", etc. Though the employment opportunity in this sector has been squeezed in the last 15 years, this sector is still offering employment to nearly 10 million weavers in rural area (Zohir, I. S. 1996). So, a lot of researchers work for developing handloom industry. Lack of Accounting Information System practicing is important reason for not developing this industry. Findings reveal that most of the Handloom industry don't follow any system of Accounting Information System either of manually or of computerized.

## 2.2. Concept of Accounting & Information System

Accounting is a systematic process of identifying, recording, measuring, classifying, verifying, summarizing, interpreting and communicating financial information. It reveals profit or loss for a given period, and the value and nature of a firm's assets, liabilities and owners' equity. (Business dictionary), The American Institute of Certified Public Accountants (AICPA-1949) defines accounting as the art of recording, classifying, and summarizing in a significant manner and in terms of money, transactions, and events which are, in part at least, of financial character, and interpreting the results thereof". Thus Accounting is referred to as a process of recording the financial transactions by maintain the first book named "Journal", posting the transactions to the final book "Ledger", summering the accounts balances in Trial Balance and finally communicating the accounting financial information to stakeholders in form of financial statements. According to IFRS-1 financial statements are of 5 in number named Comprehensive Income Statement, Statement of Financial Position, Cash Flow Statement, Owners Equity statement and Notes to the Financial statement (IASB). For these performances, voucher, files and other related supporting data are kept strictly. The whole process of accounting can be done manually or in computerized way maintaining some accounting software like Tally, Troyee and Acc. Pack. Findings showed that very few loom industries adopted accounting practices manually not completely, just keeping cash book and short form of balance sheet, not one single firm maintains automated accounting software.

## 2.3 Common Accounting Practices by Small & Medium Enterprise

The SMEs maintained by the following books of Accounts like as

**2.3.1. Journal:** According to Larson Wild Chiappetta the process of journalizing transactions, require an understanding of a journal. While a company can use various journals, every company use general journal, which shows the debit and credit of each transactions. It can record any transaction. A general journal entry including the following i. Date of action ii. Title of effects iii. Reference iv. Taka amount of each debit and credit iv. Explanation of the transaction can be seen below.

### 2.3.2. Ledger

The next step of processing transaction is to post journal entries to ledger accounts. To ensure that the ledger accounts are up to date entries are posted as soon as possible. This might be daily, weekly, monthly or when time permits. All entries must be posted to the ledger by the end of the reporting period. This is necessary so accounts balances are current when financial statements are prepared. When entries are posted to the ledger, the debit in journal entries occupy into the ledger accounts as debit, and credit are occupy into the ledger accounts as credits can be seen in the above. The following shows 4 steps to post a journal entry

- Identify debit accounting ledger, enter date, journal page amount and balance
- Enter the debit accounts number from the in the Page Reference(PR) column of the journal
  - Identify credit accounts in ledger, enter date, journal page amount and balance .
  - Enter the credit accounts number from the ledger PR column of the journal. The posting process creates a link between the ledger and the journal entry. This link is a useful cross reference for tracing an amount from one record to another.

### 2.3.3. The Trial Balance

The preparation of trial balance involve three steps:

- list each account title and its amount (from ledger) in the trial balance
- compute the total of debit balance and the total of credit balance
- Verify (prove) the total debit balance equal total credit balances. The total of debit balance equals the total credit balance for the trial balance as in above. If these totals were not equal, then one or more errors exist. However, the equality of these two totals does not guarantee that no errors were occurred. These errors post many difficulties on the small scale businesses in which we refer to in our studies as challenges. These errors can be put into two; those that affect the agreement of the trial balance totals and those that do not affect the agreement of the trial balance totals.

The SMEs have also prepared the following financial Statements:

### 2.3.4. Income Statement

According to Gupta (2012), it is the summary of such accounts, which affect the profit, or loss of the concern. These are prepared by transferring from

the trial balance all nominal accounts and accounts relating to goods by means of journal entries called 'closing entries'. All remaining accounts i.e. real and personal, relating to properties, assets, debtors, and creditors are shown in the balance sheet. In order to know the overall picture of the effect of these accounts they are grouped at one place. Items increasing profit (revenue) are put on one side (credit) and those decreasing profits (losses and expenses) are on the other side (debit). The balance is either net profit or net loss.

### Preparation of Income Statement

Income Statement is prepared mainly to know the profitability of the goods bought (or manufactured) sold by the businessman. The difference between selling price and cost of goods sold is the Gross Profit of the businessman. As per IFRS-1 total sales can be ascertained from the sales ledger. The cost of goods sold is, however, calculated in order to calculate the cost of sales. The 'cost of goods' includes the purchase price of the goods plus direct expenses relating to purchase of goods and bringing the goods to the place of business. In order to calculate the cost of goods " we should deduct from the total cost of goods purchased the cost of goods in hand. We can study this phenomenon with the help of following formula:

$$\text{Opening stock} + \text{cost of purchases} - \text{closing stock} = \text{cost of sales.}$$

For earning net profit, a businessman has to incur many more expenses in addition to the direct expenses. Those expenses are deducted from profit (or added to gross loss); the resultant figure will be net profit or net loss. The expenses, which are recorded in Profit and loss account, are called indirect expenses.

### 2.3.5. Balance Sheet

The purpose of balance sheet is to show the financial position of a given business entity at a specific date. Every business prepares a balance sheet at the end of the months and most companies prepare one at the end of each month. A balance sheet consists of listing of assets, liabilities and owners' equity of a business. The balance sheet date is important as the financial position of a business may change quickly. A balance sheet is the most useful if it is relatively recent. A Balance Sheet is a statement of the financial position of a business which states the assets, liabilities, and owners' equity at a particular

point in time. In other words, the Balance Sheet illustrates your business's net worth. (Ward, 2012) Assets are economic resources that are owned by a business and are expected to benefit future operations. Assets may have definite physical form such as building, machinery or an inventory of merchandise. On the other hand, some asset exists not in physical or tangibly forms but in the form of valuable legal claims or rights; examples are amount due from customers, investment in government bonds and patent rights. Liabilities; the person or organizations to which the debt is owed is called creditor. All businesses have liabilities; even the largest companies often purchase merchandise, supplies and service on accounts. The liabilities arising from such purchases are called accounts payables. Owners' Equity; the owners' equity in a corporation is called stockholders equity. In this discussion, we will use the broader term "owner's equity" because the concepts being presented are equally applicable to the ownership equity in corporations, partnerships, and sole proprietorships. Owners' equity represents the owners' claims to the assets of the business. Because creditors' claims have legal priority over those of the owners, owner's equity is a residual amount. Owners are entitled to what is left after the claims of creditors have been satisfied in full. Therefore owners' equity is always equal to total assets minus total liabilities

## 3.0 RATIONALE OF THE STUDY

In order to survive, SME owners and managers need updated, accurate, and timely accounting information (Lohman, 2000; Amidu and Abor, 2005). The primary purpose of an accounting information system (AIS) is the collection and recording of data and information regarding events that have an economic impact upon organizations and the maintenance, processing and communication of such information to internal and external stakeholders (Stefanou, 2006). In Bangladesh, Handloom industry as SMEs do not maintain accounting system properly and it is one of the reasons for diminishing the loom industry. So it is rationale to identify the real scenario of practicing the Accounting Information System adopted by Loom industry and reasons of that situation. This study will also investigate to know the relationship between AIS and profitability of the Handloom industry of Bangladesh.

## 4.0 RESEARCH QUESTIONS

Manual accounting system practicing or accounting software adoption or non-adoption is an important challenge of the loom industries in the modern technological business world. It can also be said to be the violation of the accounting conventions and rules in recording and posting of accounting transaction. This can affect or not affect the agreements of the trial balance; hence, it may affect or not affect the preparation of the final accounts. Therefore, some research questions arise in the brain of the researcher, which are as follows:

1. What is the extent to which accounting information systems have been implemented and applied in the Handloom industry of Bangladesh?
2. What is the relationship between accounting information & profitability of Handloom industry of Bangladesh?
3. What is the impact of accounting information system on Handloom industry's overall financial performance?

## 5.0 OBJECTIVES OF THE STUDY

The main objective is to assess the adoption of accounting information system practices and its effect on Handloom industries of Bangladesh. The specific objectives of the study are:

- i. To determine the extent of implementation of Accounting Information System in the Handloom industry of Bangladesh;
- ii. To Analyze the relationship between Accounting Information & profitability of Handloom industry of Bangladesh;
- iii. To identify the impact of Accounting Information System on Handloom industry's overall financial performances.

## 6.0 REVIEW OF RELATED LITERATURE

Since SME has its importance in economy there are plenty of studies on this business and on AIS which is the oldest and most important sub-system of MIS. Dalğar,(2014) search to what extent AIS is used in production companies and they carry out a questionnaire in production companies which are in West Mediterranean Region. In this study, it has been seen that in production companies every data needed is recorded; the information technology was used

effectively in these companies; stock companies use AIS more efficiently than other companies. Akgün and Kılıç (2013) discuss AIS and MIS in conceptual basis in their study. They carry out a questionnaire to determine the efficiency of AIS in Tuz Lake (Salt Lake) businesses. According to the result of this questionnaire they pointed out AIS provides information for internal and external users. It is also seen that AIS has a positive effect on the efficiency of the business management. Yazıcı (2010) makes a study about the effects of AIS on managerial decision in SMEs in the Erzurum Organized Industry Zone. According to his research results when businesses get larger, the number of personnel and the level of technology use increase, AIS is used more efficiently in managerial decisions. Gökdeniz (2005) states that AIS is the most important sub-system of MIS and the input of AIS is recorded more easily by computerized system and the output is reliable and certain. Also AIS education provides many advantages to the businesses. Mizrahi (2011) focuses on the effective use of AIS in SMEs. According to her study the SMEs in İzmir only use 35% of their AIS knowledge in their managerial studies. In their study Allah, et al., (2013) aim to show to what extent small businesses use AIS and states that small businesses are unwilling to use new technology in their businesses.

## 7.0 RESEARCH GAP

There are plenty of research on SMEs performance as well as impact of AIS on SMEs performance. Md. Faykuzzaman Mia (2017) writes an article and tries to see the positive relationship of accounting information with small scale of business profit. Abdullah, S. S, Azim Md. Sh. and Ramanchandram, R. (Malaysia 2017) state in their research that information system (IS) has positive impact on firms performance, specially SMEs. Liton M. R, Liton I, , Islam T and Saha S (2016) found some reasons for shutting down of looms in Bangladesh: lack of capital, lack of raw materials, inadequate technology, poor marketing system, inadequate government support etc. But it is a question whether Loom industry are suffering from malpractice of accounting information system or not. No research is found here related to impact of AIS on Handloom industries of Bangladesh, although this historical industries weavers are migrating to other services day to day (Banarjee S. Moniruzzaman Muzib M.



M & Sharmin Sh.2014). This study will fill up the gap and will identify the extent of practicing of AIS by Loom Industries and to analyze the relationship between AIS and firms financial performance.

## 8.0 METHODOLOGY OF THE STUDY

### 8.1 Research Design

A qualitative research design will be employed. For the purpose of the study a non-probability sampling design in the form of a convenience sampling method will be adopted and considered to be appropriate to gather primary data.

### 8.2 Type and Data Source

Both primary and secondary data sources will be used in the entire study. Secondary data are information that has already been collected by other researchers including both published and unpublished relevant literature such as textbooks, journals, newspapers, internet documentaries among others and other institutions like Bangladesh Handloom Board (BHB), Bangladesh Small Industries and Commerce (BSIC), and Bangladesh Bank (BB). For the primary data, semi-structured questionnaire survey will be employed.

### 8.3 Data Collection Procedure

Since most of the respondents do not have finance background, the researchers will explain most of the technical terms to help in obtaining the appropriate responses. During the visits to the respondent business offices, opportunity will be taken to observe how things were done in the various Loom industries.

### 8.4 Type of Data and Data Collection Tools

Qualitative data was mainly collected. Descriptive information such as information on challenges of accounting information system practice and its effects are few of the qualitative data has been collected. Descriptive summary and statistical tools has been used to describe the demographic profiles of the study population. The instruments used to gather the data was the administration of semi-structured questionnaires.

### 8.5 Target Population

The target population for this study was Handloom, Power loom and Pit loom industry owners, and officials situated in six districts of Bangladesh.

The districts are Sirajgonj, Pabna, Tangail, Dhaka, Narayanganj, and Narshingdi.

### 8.6 Sampling Procedure

Fellows and Liu (1997) assert that population parameters and sampling procedures are vital in the success of a study. So, these techniques were applied.

### 8.7 Sampling Type

Chilipunde (2010) added that, Naoum (2007), and Fellows and Liu (2007) define Random sampling – as a sampling procedure where the sample is derived by randomization process from a homogeneous or homogeneous conglomerate texture population. So, random sampling procedure was used for this study.

### 8.8 Sampling Size

A sample size of 30 Handloom, Power loom and Pit Loom industry owners of six districts of Bangladesh, were examined.

### 8.9 Data Presentation and Analysis

Data processing tools like the Statistical Package for Social Scientists (SPSS) 16.0 and Microsoft Excel were used to analyze data and findings have been presented using frequency tables, percentages and charts.

## 9.0 ANALYSIS AND INTERPRETATION OF DATA

### 9.1 Demographic characteristics

Out of 30 sample size, 83.3% were male and 16.7% were female. Also, 19 (63.3%) fell between the ages of 18 to 35 years followed by those who fall between 36 to 45 years 6 (20%) and then 46 to 59 years 4 (13.4%). The findings revealed that 16 (53.3%) have basic (primary) and secondary educational background with 12 (40.0%) in tertiary level and other 2 are illiterate.

### 9.2 Accounting Record

Keeping Out of the 30 respondents interviewed 20 (66.7%) keep accounting records while the remaining 10 (33.3%) do not keep any records.

### 9.3 Types of Records Kept By Respondents

The table below shows the various types records kept by the 20 respondents who keep accounting records.

**Table 1.** Types of records kept by respondents

Types of records	Frequency	Percentages
Cash book	18	90.0%
Journals	-	-
Ledgers	-	-
Balance sheet	-	-
Income Statement	2	10%
Others	-	-
Total	20	100%

**Source:** Field survey, October 2018

Of the thirty (30) respondents, 20 keep records representing 66.7% out of which 18 (90%) keep cashbook, and 2 (10.0%) maintain Income Statement. None of the respondents keep journal, ledgers, and balance sheet. From the statistics above, a small percentage, prepare Income Statement while a higher percentage kept cashbook and this is prone to errors as knowledge of accounting is absent. We found out that of the 10 respondents who do not keep records, majority 8(80%) rely on their memory without documentation and the remaining 2 respondents could not pin to no specific order of keeping record for their operations. A cross tabulation revealed that, out of those who kept records, majority (70%) have obtained basic education with the rest (30%) being those in tertiary education. Despite their size for this research, females seem to have taken record keeping serious in their venture as three out of the five selected were among those who kept records.

#### **9.4. Times of Keeping Accounting Records**

Out of the 20 respondents who keep records, 15 (75%) adopts accounting practices at the commencement of their business while 5 (25%)

adopt accounting practices between 1 to 2 years after commencements. The chart below depict when Handloom Industries owners who keep accounting records adopt it.

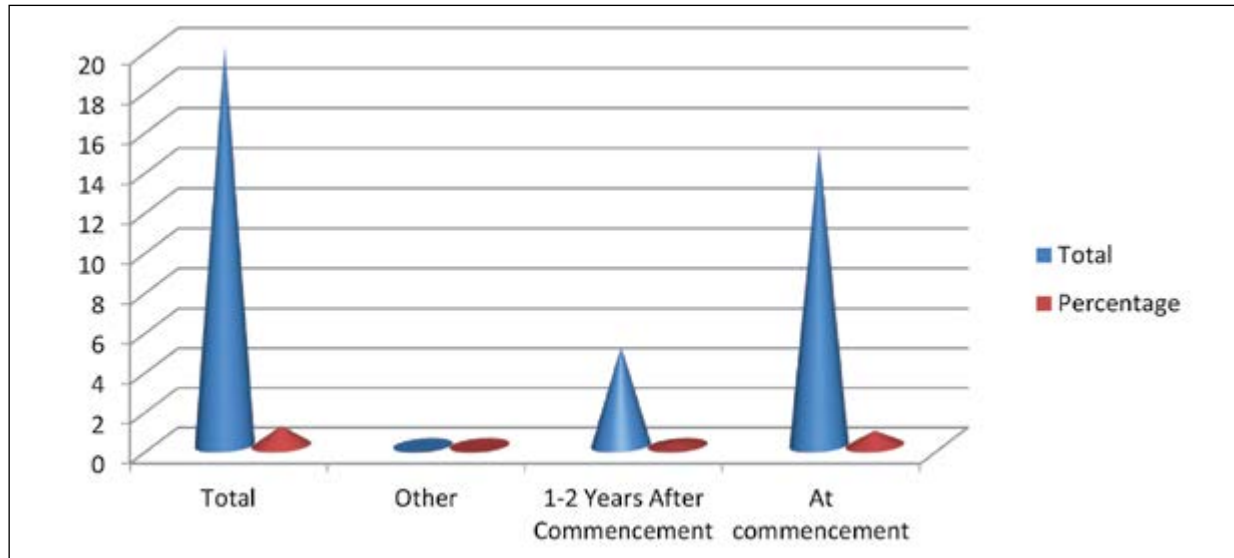

**Fig 16.** Periods of accounting practices were adopted by 20 respondents

**Table 2.** Challenges encountered by respondents

Challenges	Frequency	Percentages%
Unable to separate business from private issues	4	26.7
Unable to identify all expenses incurred by the business	1	6.7
Unable to state actual revenue	8	53.3
Unable to complete accounting records	2	13.3
Others	0	0
Total	15	100

**Source:** Field survey, October 2018

out of 15 respondents who encounter challenges in accounting practices during the operation of their business, 4 (26.7%) are unable to separate their business from private issues, 1 (6.7%) is unable to identify all expenses incurred by the business, while 8(53.3%) cannot state the actual revenue accrue by the business and 2(13.3%) are unable to complete their accounting records. The five respondents who asserted they do not encounter challenges in accounting practices gave factors such as quality personnel, adequate training, effective internal control and good conducts. On the causes of challenges in accounting practices among the 15 respondents, 11 (73.0%) gave lack of training as the causes of challenges in accounting of their business, negligence (13.3%), willful misconduct (6.9%) and others like time constraints (6.9%) as the reason for challenges in accounting practices. In finding out whether these challenges in accounting practices affects their businesses, out of 15 respondents, 90% indicated it affects their business while the remaining 10% claim the challenges have no effects on their operations.

The table below indicates the effects of challenges in accounting practices on Handloom Industry.

**Table 3.** Effects of challenges on Business

Effects of challenges on business	Number	Percentage %
Financial loss	10	71.4
Poor record management	1	7.1
Less credit worthiness	3	21.4
Others	0	0
Others	14	100

**Source:** Field survey, October 2018

Out of 14 respondents who agree that the challenges in practicing accounting, negatively affect their business, majority (71.4%) mentioned that it leads to financial loss followed by less credit worthiness (21.4%) and poor record management (7.1%). On the field, we asked producers whether there has been a change in the challenges they face after they

adopt accounting practices. It was revealed that, of the 5 respondents who adopt accounting practices 1-2 years after commencement, 4 (80%) agree that they had been a positive difference between the time they were not keeping account records and the time they adopted accounting practices, while only one producer admitted that there is no difference.

### 9.6. Positive ways to solve these challenges

On efforts, put in place to address challenges in accounting practices, faced by Handloom Industries owners, out of the 14 producers who asserted that challenges in accounting have negatively affected them, half (50.0%) and 5 (35.7%) said effort of management and employees and, continual workshop can remedy the challenges. However, the remaining 2 (14.3%) producers have not been able to unravel these challenges. In finding reasons why despite efforts put in place the mentioned challenges still exist, it was revealed that of the 14 producers, 10 (71.4%) said professional bodies in the sector have not attach seriousness to accounting in the business and 2 (14.3%) attributed it to lack of interest by managers and employees. The remaining 2 (14.3%) producers have stated that no serious punishment have been executed out on those who have violate the accounting standards due to negligence or willful misconduct. Largely, we sought the opinion of the 15 who encounter challenges in accounting practices on ways to solve these challenges. The table below depicts the result:

**Table 6.** Ways to solve challenges in accounting practices

Responses	Frequency	Percentage (%)
Adequate professional training	3	20.0
Organizations goal should precede individual goal	2	13.3
Effective internal control	8	53.4
Motivation of employees	2	13.3
Others	0	0
Total	15	100

**Source:** Field survey, October 2018

From the table above, plurality of producers have the views that effective internal control (53.4%) followed by adequate professional training on

accounting in the small-scale business (20.0%) can promote accounting practices. The remaining 26.6% think organizations goal should precede individual goal and motivation of employees will work out the challenges of accounting practices in the sachet water enterprise.

## 10.0 FINDINGS OF THE STUDY

### 10.1 Demographic characteristics

Males were found to dominate the Handloom Industry than their female counterparts. More females can therefore take advantage of this production sector especially those acquiring accounting skills and knowledge can become part-time or full-time staff in this sector. It was also observed that majority of Handloom Industries owners are within the active group and have attained the level of basic and secondary education showing that almost all are inadequately qualified in the accounting field leading to inefficiency in accounting practices. They can therefore utilize opportunities to acquire accounting profession.

### 10.2 Accounting Record Keeping

It is observed that majority (66.7%) keep accounting. This also implies that efforts are being made by this small-scale enterprise to gather some accounting information despite their low level of education. On the other hand, while the 33.3% who do not keep any records points that they face negative effects of accounting practices and therefore calls for urgent attention in providing them with basic accounting training as they were found to have attained primary education.

### 10.3 Types of Records Kept By Respondents

For those who keep accounting records, a small percentage, prepare trading profit and loss accounts while a higher percentage kept cashbook and this is prone to errors as knowledge of accounting is absent. Other forms of records kept by respondents who do not keep accounting records were that majority get their business transaction from their memory while others have no specific order of keeping records. This is a serious challenge that affects the success of most Handloom Industry.

### 10.4 Accounting Record Keeping Time

In ascertaining when Handloom Industry owners who keep accounting records adopt the accounting

practices, majority adopts accounting practices at the commencement of their business while minority adopt accounting practices between 1 to 2 years after commencements. With this information, one can conclude here that despite their background they ensure that accounting is being practiced and therefore hope that one could trace their financial status.

### 10.5 Challenges in Accounting Practices

This higher percentage (75%) out of the 20 who keep accounting records who testified that they encounter challenges in accounting practices indicates that great number of Handloom Industry owners have no knowledge in accounting practices. Majority (53.3%) testified that they cannot state the actual revenue accrued by the business followed by their inability to separate their business from private issues. Other challenges identified were inability to identify all expenses incurred by the business and their inability to complete their accounting records. This reveals that mismanagement, loss of business assets and, uncertainties in business operations, were challenges encountered by Handloom Industry owners in the area of their business when they were not keeping accounting records. Those who asserted they do not encounter challenges in accounting practices gave factors such as quality personnel (mainly those who had basic accounting in secondary and training colleges), adequate training, effective internal control and good conducts.

### 10.6 Causes of Challenges in Accounting Practices

In causes of challenges in accounting practices, the main finding of this study was that most Handloom Industry admitted that lack of adequate training is the major cause of challenges in accounting practices. This is, as a result of the fact that Handloom Industry within this part of the country is less creative and hence, employing well qualified personnel will mean paying more for such employees who in actual fact may not generate enough revenue to meet their pay. On the other hand, such qualified personnel have set their eyes on well-paying jobs and consider work with Handloom Industry as not deserving their level of qualification. The study also brought to light the fact that, willful misconduct is another major cause of the challenges in accounting practices. This is manifested in the fact that accounting officials in their bid to satisfy their selfish interest misrepresent facts in accounting records leading to undesirable

consequences of challenges. Another predominant cause of challenges in accounting practices which generated as a result of the study had to do with negligence. This is so because some accounting staffs do not attach seriousness to their work hence they neglect their duty of ensuring good and sound accounting practices. The study has proved beyond all reasonable doubt that challenges in accounting practices have affected negatively on the life and growth of Handloom Industry in the districts of Sirajgonj, Pabna, Tangail, Dhaka Benarashi polli, Narayangonj Rupgnj and Narshingdi of Bangladesh.. Among these challenges have resulted in poor record management and have extensively cause financial loss to Handloom Industry, as they are not able to separate business from private issues, under casting or over casting of revenue etc.

### 10.7 Effects of Challenges in Accounting Practices

The findings revealed that out of 15 respondents who testified to encounter challenges, 14 of them indicated that these challenges affect them. It was brought to light the fact that majority of the Handloom Industry whose accounting records are beset with challenges face financial loss, lack the credit worthiness of accessing loan and funding for further investment hence their ability to grow. We also found out that persistent challenges in accounting practices within a firm will cause it to lose its goodwill, the level at which the public would wish to do business with the enterprise will dwindle as a result of the challenges in accounting practices of that enterprise.

### 10.8. Possible Solutions to the Challenges in Accounting Practice

In their attempts to address the challenges in accounting practices, the respondents claimed that one way to find solution to these challenges is to encourage both management and employees to put much effort in ensuring effective accounting practices. They also mention job training through continual workshop can upgrade their skills and afford them the opportunity to learn new principles introduced in the accounting profession. This they believe when properly handled will benefit many people including those who did not previously have knowledge in accounting as they learn the basics of book keeping techniques for the small-scale businesses. Additionally, the respondents were of the view that accounting bodies and Bangladesh Handloom Board that set standards for the profession should consider it a duty to make



available text and guidelines on sound accounting practices from time to time. This will go a long way to give assistance to those who have the self-esteem ego of not consulting others for guidance where they fall short to teach themselves to understand and put into practices good accounting techniques to avoid challenges in accounting practices. In pursuing this research, it became known that one way of addressing the challenges lies in the fact that people who want to pursue accounting as a profession should in fact go in for the necessary professional training to equip themselves with all the skills needed to function effectively as accountants or account officers. The study also identified the fact that when staff learn to prioritize, thus to let organizational goal precede individual goal, it will in a way reduce drastically the issues of accounting challenges. Majority suggested effective internal control as one of the major ways of finding solution to the issue of challenges in accounting practices.

## 11.0 CONCLUSIONS AND RECOMMENDATIONS

The main objective of the study was to assess the adoption of accounting practices and its effects on Handloom Industry of Bangladesh. It is evident from these findings that majority of the Handloom Industry adopt accounting practices. However, challenges in accounting practice have been a common feature associated with most Handloom Industry. Among the factors that were identified include lack of training, willful misconduct, negligence etc. It was also revealed that there low level of education and ignorance affects producer's adoption of accounting practice, hence a great number of Handloom Industry owners in the area operate without accounting knowledge despite their successes. These challenges affect negatively on the growth of these enterprises as they cause cash drainage, financial lost and low profitability. Financial loss, limited access to credit and dented image are other effects of these challenges. Serious measures therefore need to be adopted to minimize if not eliminate these challenges in accounting practices among the Handloom Industry firms. Knowing the fact that lack of professional training regarding AIS adoption is the major cause of the challenges in accounting practices, account officers in the Handloom Industry sector should be encouraged to go in training to acquired knowledge and skills needed to perform accurate accounting

procedures. Since our focus is on Handloom, Power loom and Pit loom Industries, it will be a step in the right direction, if government, non-government organizations take it upon themselves to provide accounting in-service or on-the-job training for financial managers or owner-managers in this sector to improve their knowledge. Most of the challenges that are recorded are because of lack of knowledge in accounting by financial managers who are the key financial planners and managers of the enterprise. Their inefficiency will affect the whole accounting system in the enterprise. Handloom Industry should learn how to maintain strong internal control system to check the practice of misappropriation of funds in the enterprise. Internal control system is a very important tool in accounting system in which every transaction is needed to pass through in an accounting cycle. This is to check the accuracy and reliability of every transaction in the business. With this, if businesses maintain a strong internal control system those challenges will not be recorded in the whole Handloom sector of Bangladesh. Qualified personnel should always be employed and placed appropriately to enhance efficiency in accounting practice. If these personnel are not employed rather than unqualified accounting practitioners, this will result in challenges in accounting practices and waste of funds of the enterprise involve. Good motivational packages should be given to the employees to ensure their accuracy and reliability in their recording of financial transactions of the business. When employees are given adequate motivational packages it will discourage them from using non-approved methods in recording the business financial transactions. Motivational packages also enhance employee's efficiency and morale, as they are aware of packages to be received.

## References

- [1] Abedin, M, J (2018) Role of SME clusters in Bangladesh economy, The Independent, dated 29/10/2018.
- [2] Ahmad, MU (1999), 'Development of Small-scale industries in Bangladesh in the New Millennium: Challenges and Opportunities', Asian Affairs, vol. 21, no.
- [3] AL Smirat BY (2013) The use of accounting information by small and medium enterprises in south District of Jordan, (An empirical study). Research Journal of Finance and Accounting 4: 169-175.
- [4] Asian Development Bank (ADB) 2002, "'Strategic Issues and potential Response- Small and medium Enterprise Development and export expansion'", Yearly Report, Research, Asian Development

Bank, ADB, Dhaka.

[5] Banarjee, S.; Muzib, M. M. and Sharmin, S. (2014), Status of Handloom Workers and Causes of Their Migration: A Study in Handloom Industry of Tangail District, Bangladesh, Research on Humanities and Social Sciences, Vol.4, No.22, 2014.

[6] Bangladesh Bureau of Statistics (BBS). (2005). Report on Bangladesh Handloom Census 2003. Dhaka: Planning Division, Ministry of Planning.

[7] BHB (2012), 'Importance of Handlooms in Bangladesh', Article, Bangladesh Handloom Board, Bangladesh Handloom Board, Bangladesh Handloom Board, Dhaka.

[8] Bhattacharjee, D. and Khaled, M. (1969). Marketing of Small Industries Products in East Pakistan. Dhaka: Bureau of Economic Research, Dhaka University.

[9] Ismail NA, King M (2007) Factor influencing the alignment of accounting information systems in small and medium sized Malaysian manufacturing firms. Journal of Information Systems and Small Business 1: 1-20.

[10] Khondoker, A. M and Sonobe, T. (2011), Determinants of Small Enterprises' Performance in Developing Countries: A Bangladesh Case, The National Graduate Institute For Policy Studies (GRIPS), Tokyo, Japan, January 2011. Online at <https://mpira.ub.uni-muenchen.de/44006/> MPRA Paper No. 44006, posted 27 January 2013 00:27 UTC.

[11] Latif, Muhammad Abdul. (1997). Handloom Industry of Bangladesh 1947-1990. Dhaka: University Press Ltd.

[12] Liton M. R. I, T. Islam, S. Saha. (2016) Scenario and Future Challenges in Handloom Industry in Bangladesh Social Sciences. Vol. 5, No. 5, 2016, pp. 70-76.

[13] Rahmatullah M.N, Begum R, Naha K. and Sultana R. (2010) Effect of Microcredit on Handloom Weavers of Grameen-Check Producers of Sirajganj District of Bangladesh: A Case Study in Six Selected Villages Journal of Experimental Sciences Vo l. 1, Issue 4, Pages 21-26.

[14] Zohir, I. S. (1996): "An Assessment of Industrial Policy in Bangladesh": What Policies are We Talking About?"

[15] [https://en.wikipedia.org/wiki/Small\\_and\\_medium-sized\\_enterprise](https://en.wikipedia.org/wiki/Small_and_medium-sized_enterprise).

[16] <https://stats.oecd.org/glossary/detail.aspID=3123> (OECD SME and Entrepreneurship Outlook ,2005, OECD Paris, page 17)

[17] <http://www.businessdictionary.com/definition/accounting.html>.

# SUSTAINABLE FINANCE FOR GROWTH AND DEVELOPMENT OF BANKING INDUSTRY IN BANGLADESH: AN EQUITY PERSPECTIVE

**Dr. Mohammad Zahir Raihan**

Associate Professor (Finance)  
School of business, Bangladesh Open University  
E-mail: raihan\_bou@yahoo.com

## ABSTRACT

The present study is about sustainable finance- a prerequisite for growth and development of banking industry in Bangladesh. The study is based on a total number of 20 commercial banks and total 120 respondents consisting the bank owners. This study is an outcome of both the primary and secondary data. The requisite primary data were collected using structured questionnaire. The main objective of this study is to critically evaluate the role of sustainable finance in the growth and development in the banking industry in Bangladesh. This study reveals that the levels of perceptions of the most of the respondents were found to be very high in terms of their awareness, beliefs, attitudes and understanding as regards the dimensions of sustainable finance viz. customers' satisfaction, employees' welfare, contribution to govt. exchequer, generating revenues, cost savings, products or services with rescannable charge, brand awareness and addition to capital and the shareholders' equity representing value of the firm was found to be influenced to the extent of 41.6 percent by the relevant independent variables representing sustainable finance of the sample banks. The major suggestions for addressing challenges put forward by the respondents have been loan sanctioning founding on proper appraisal of loan applications and improving operational efficiency. The relevant bank authorities should implement the suggestions in order to improve the sustainable finance related factors.

**Key words:** Sustainable finance; shareholders' equity; corporate social responsibility; investment; net cash flows; cost savings.

## 1.0 INTRODUCTION

Sustainable finance and sustainable development refer to an evolutionary change from the present situation to a better situation which is a process of building, improving and innovating for ensuring better quality of life of human beings. Therefore, sustainability is a basic to human welfare and it is a never-ending development process. Sustainable development is the optimal and rational use of resources which can bring the long-lasting benefit maximizing the use of development resources but minimizing the damage to the environment (Solaiman and Azad, 2009). In such a context, finance required for maintaining sustainable development may be viewed as sustainable finance.

In its most basic definition, finance is the action of distributing capital to individuals and companies that wish to make productive use of it. In short, finance makes social value (Leon Patrica 2001). The second half of the 20th century can be branded in over-all as an era of strong economic growth. After a recession in the mid-1970s and a moderately small fall in the stock market in 1987, there was a durable bull market until March 2000 (Eke & Olokoyo, 2017).

With the downfall of the Internet exaggeration in the succeeding period, we go in a serious bear market (or a stock market collapse extended over time) with frequent reported fraud cases (more or less). In such conditions, it is not surprising that concepts such as sustainability, social responsibility and business ethics have attracted much consideration (Soppe,

2004). The financial crisis of 2008 is just the utmost recent and most dramatic proof that today's finances acquire a totally different meaning and, according to some, less social awareness.

It is supposed that we have the chance and responsibility to teach, practice and research finances differently. Sustainable financing is the practice of forming economic and social value through financial models, products and markets that are sustainable over time. Accomplishing financial sustainability is a long-standing objective that needs the intensive efforts of the whole organization.

We must recognize that succeeding financial stability is a continuing procedure that can become part of our organization's day-to-day management: strategic planning, administration and finance, fund raising policies, and planning and implementation of policies that empower us to make our own returns. On the edge of the 21st century, in the face of a gradually competitive market, a globalized economy and a context in which variation is an endless rather than a variable, we must use more refined methods to accomplish financial sustainability. The survival of the sector be contingent on our ability to achieve this goal (Leon Patrica, 2001).

We must also remember that creativeness alone is not sufficient to accomplish financial sustainability; it is important that we adopt the most progressive policies and approaches at our disposal to maximize our resources for achievement. Reaching financial sustainability should no longer be an unbearable dream. Attaining this objective is both a requirement and a commitment for organizations, as it guarantees our ability to fulfill our particular assignments.

In case of banking industry in Bangladesh, sustainable finance must be maintained for the smooth running of the banks in one hand, and for the growth and development of the banks, on the other hand. The commercial banking sector does not deliberate poor people primarily because of their incapacity to meet the suitability criteria, including guarantees. Therefore, the poor in Bangladesh have virtually no access to formal financial services (Anwarul Islam & Zaman, 2013). In such a context, the more rational way to help the poor could be the provision of sustainable economic opportunity at a grass root level especially provision required financial services

at competitive rates to support their investment including viable business activities.

Therefore, the question of sustainable finance is obviously related to the growth and development of banking industry in Bangladesh. This situation has motivated the researchers undertaking an in-depth study on sustainable finance in the context of banking industry in Bangladesh. So far researcher knowledge goes, no worth mentioning study was done on sustainable finance in the context of banking industry of Bangladesh. However, the present study is an effort to the end.

The main objective of the study is to critically evaluate the role of sustainable finance in the growth and development of banking industry of Bangladesh. More specifically, to measure the perceptions of the selected bank owners regarding various dimensions of sustainable finance and to measure the impact of banks' sustainable finance on the growth and development of the sample during the study period.

For the purpose of the study, the following hypotheses were relevant which had been developed on the basis of the main objective of the study.

1.  $H_0$ : There exists no relationship between shareholders equity representing value of the firm and each of the measures of sustainable finance.
2.  $H_a$ : There exists relationship between shareholders' equity representing value of the firm and each of the measures of sustainable finance.

## 2.0 RATIONALE OF THE STUDY

In Bangladesh, a good number of commercial banks both local and foreign have been providing financial services to the society, generating employment opportunities for the unemployed people and contributing to the government exchequer in the form of tax and vat (value added tax) etc.(Rahman 1996). Hence, the question arises, which banks are bad, good, better and best from the viewpoints of liquidity, profitability, solvency, operating efficiency and in turn, financial sustainability. Since, banks deal in public money, public confidence is a must for sustainable finance of the banks. Of the general public, bank owners and employees, banks clients and customers directly and other businessmen and industrialists and service holders or other professional people

indirectly involve in banking activities. Therefore, the confidences of the agents depend on efficiency, liquidity, profitability, solvency and in turn financial sustainability of the banks with which they are involved directly or indirectly. Financial sustainability of the banks depends on some qualitative and quantitative factors (Adongo and Stork, 2006), of the various quantitative factors, generating revenues, cost savings, risk reducing, addition to capital, economic value added, and contribution to govt. exchequer etc. are the main. Again, of the qualitative factors, employee welfare, building trust, building image, community interest, publicity, product/service with reasonable charge, brand awareness, ethical responsibility, legal responsibility, emission of carbons, bio-gas plan and solar panel, waste management, maintaining ecological balance, environmental conservation are the major. Sustainable finance produces impact on the value of the firms representing shareholders wealth on which the ultimate growth and development of the firms depend.

Sustainable finance- a prerequisite for growth and development of banking Industry in Bangladesh is an effort which would give the answers to those questions. Therefore, the findings of the study would be useful to the bank authorities while making strategic planning for sustainable finance of their relevant banks. The Bangladesh Bank (BB) authority as the regulatory body of the commercial banks would also be able to frame the realistic as well as robust policy as to sustainable finance in the case of the banking industry in Bangladesh. Moreover, the prospective researchers would be benefited out of the findings of the study in order to carry on further researches on this vital issue. Again, both the prospective clients and customers of the banks would also be benefited from the relevant banks if the banks have the financial sustainability for the continuation in the future. Lastly, the study would contribute, to some extent, to the existing stock of knowledge on this vital issue.

### 3.0 LITERATURE REVIEW:

Sustainability in finance is understood as a strategic choice based on normative decisions on how to run a company in the long term. Research on sustainable finance aims to fill the gaps between finance and corporate strategy. Sustainability as a social phenomenon entered economic literature many decades ago. Eke and Olokoyo (2017) exposes

that, primarily, sustainability was launched in strict environmental interpretation during the United Nations conferences in the 1970s and 1980s. Then, during the 1980s and 1990s, sustainability gradually entered into the business ethics literature and management literature as an internal responsibility of corporations and management, designated as Corporate Social Responsibility (CSR). Therefore, in the finance world, current literature on the financial sustainability and its major dimensions are not adequate. However, studies directly related to sustainable finance have been reviewed as follows.

Soppe (2004) presents and demonstrates the concept of sustainable corporate finance. Sustainability is a well-established concept in the disciplines of environmental economics and business ethics. The document uses a broader definition of what is called "the company" to signal sustainability to the financial literature. The concept of sustainable finance is compared to the traditional and behavioral finance. Four criteria are used to systematically analyze the basic difference. First in the order is the theory of the company: the definition of the company is reconsidered by integrating behavioral aspects and expanding the financial analysis to an establishment of three-dimensional objectives. Secondly, the assumed behavior of economic agents and their consequences for the applied methodology are observed more closely. Third, the shareholder paradigm is discussed in the context of the growing importance of stakeholders. Finally, the fourth criterion deals with the different ethical frameworks and their implications for financial behavior.

Similarly Sultana and Akhter (2015) exposed that the most significant factors for sustainability are environmental and social responsibility, customer satisfaction, financial performance, political and economic factors, responsibility and transparency, smart competition, operational efficiency, employee satisfaction and legal factors in the context of Commercial Banks in Bangladesh. In the same way Kinde (2012) in his study agrees that microfinance paradigms focus on poverty reduction through improved access to financial and financial services. However, the optimistic influences of microfinance institutions on the wellbeing of the poor can only be continued if the institutions can achieve good financial performance. The purpose of this study, therefore, was to identify the factors that affect the financial

sustainability of microfinance institutions (MFIs) in Ethiopia. The study followed a quantitative research approach using a balanced panel data set of 126 observations from 14 MFIs during the period 2002-2010. The study found that the breadth of microfinance reach, the depth of reach; the dependency ratio and the cost per borrower affect the financial sustainability of microfinance institutions in Ethiopia. Vijfvinkel, Bouman and Hessels (2011) in his study focuses on the relationship between environmental sustainability and the financial performance of SMEs in terms of profit development and income development. The analysis uses a unique data set of 337 Dutch and Chinese companies. The results suggest a significant positive association between environmental sustainability and company performance.

An additional, Pelozo and Yachnin (2011) in their study exposed that, no doubt, there is a small and positive relationship between sustainability and the financial performance of the company. This report shows that there are no consistent metrics to measure sustainability, and little attention is paid to metrics that address the causality between investments in sustainability and financial performance. This systematic review of 159 research documents and professional reports identified 39 unique sustainability measures used to examine the relationship between sustainability and financial performance. Rai and Rai (2012) in their study emphasize that millions of people in developing countries have had access to formal financial services through microfinance programs. However, millions of potential custom-

ers still do not receive service and the demand for financial services far exceeds the supply currently available. Given the significant capital constraints, the expansion of microfinance programs remains a formidable challenge for the microfinance industry. In addition, it is noted that financial institutions have had varying degrees of sustainability. One of those sustainability is financial sustainability.

#### 4.0 METHODOLOGY OF THE STUDY:

The methodology of this study has been discussed briefly as follows:

**4.1 Sampling design:** At first, the selection of sample units arises. At present, a total number of 47 commercial banks have been operating in the country, Bangladesh. Of the total number of banks, including 4 specialized banks belongs to the public sector and the remaining 39 belongs to private sector. Out of the private sector banks 38 are local and 09 are foreign. Lastly, out of the private sector local banks, 23 are conventional and 8 are Islamic shariah based (Activities of Banks and Financial Institutions 2012-2013). Out of a total of 38 private banks, 20 were selected for the study purpose based on simple random sampling. Thus, the sample size has covered 42.55 percent of the total population. At the next stage, selection of respondents arises.

Three types of **respondents numbering 20** were selected bank owners. Table-1 presents the distribution of total respondents.

**Table1.** Distribution of Total Respondents

Type of Banks	Total	Selected	Respondents
Local conventional banks	22	15	90
Local Islamic banks	8	5	30
Foreign Conventional	9	0	0
Public Sector	8	0	0
Total	47(100%)	20 (42.55%)	120

**Source:** Based on Activities of Banks and Financial Institutions, 2012-2013

It is revealed from Table 1 that the total number of respondents of all types 120 have been distributed as 120 banks owners. These respondents were selected on the basis of convenient sampling considering appropriate answers of the questions from the relevant executives.

#### 4.2. Collection of Data:

The requisite primary data were collected by the researchers themselves from the respondents on the basis of direct interview method. The instrument as used was structured questionnaire of direct interview method. The questionnaire was prepared on the basis



of the objectives of the study. Before finalization of the questionnaire, a pilot survey on 15 banks owners was conducted, in order to test the quality and validity of the questions and answers. The main sources of collection of secondary data have been the Annual Reports, Annual Accounts Statements, other relevant statistics and websites of the sample banks. There were collected by the researchers themselves from the relevant sources.

#### 4.3. Methods of Analysis of Data:

The primary data were processed with the help of computer MS word & MS Excel. On this context, descriptive statistics like mean score, Standard deviation, Coefficient of variation etc. were used. The secondary data were processed and analyzed by using SPSS (Statistical Package for Social Science) program. In order to show the relationship between the dependent variable & each of the selected independent variables, Pearson correlation technique was used. In order to measure the impact of the independent variables on the dependent variable, regression model was used. For the purpose of hypotheses testing, t test, F test and ANOVA have been applied in the study. Besides, in order to assess the qualitative responses such as awareness, attitudes, beliefs, understanding, rating importance etc.; the qualitative scale has been converted into quantitative by using 5-point Scale (Khaleq et al.1995) From the hypotheses of the study it can be said that value of the firm represented by shareholders' equity is a function of operating income, total investments, loans & advances, economic value added, total deposits, liquidity position, debt-equity ratio, return on capital, internal fund, net cash flows, contribution for employees' welfare etc.; CSR investment and number of employees and net cash flows. In order to test the hypotheses namely impact of sustainable finance on banks growth and development, the

following model has been developed by using Ordinary Least Square (OLS) method.

$$SE = \beta_0 + \beta_1OI + \beta_2TI + \beta_3EVA + \beta_4TD + \beta_5IF + \beta_6LP + \beta_7LA + \beta_8DR + \beta_9ROA + \beta_{10}CSRI + \beta_{11}EWC + \beta_{12}NOE + \beta_{13}NCF$$

Where,  $SE$ = Shareholders' equity is the proxy of the value of the firm ( $VF$ )

$\beta_0$ =Intercept of the regression line,  $\beta_1$  to  $\beta_{13}$ = Coefficients of Independents variables

$OI$  =Operating income,  $TI$  =Total investments,  $EVA$  = Economic value added,  $TD$  = Total deposits,  $IF$ = Internal funds,  $LP$ = Liquidity positions,  $LA$ = Loans and Advances,  $DR$  = Debt ratio,  $ROA$  = Return on capital,  $CSRI$  = Corporate social responsibility investment,  $EWC$ = Employees' welfare contribution,  $NOE$  =Number of employees,  $NCF$  =Net cash flows

#### 5.0 FINDINGS AND ANALYSES:

The major findings of the study have been analyzed in the following subsections having considered the objectives of the study consecutively:

The sustainable finance is frequently defined as addressing financial, economic, social, ethical, and environmental and governance impacts of financial services. The sustainability approach is challenging the core business of the financial industry especially banking industry (governance, products, process, operations and logistics). The providers of financial services (banks, intermediaries etc.) increasingly realize that the sustainable practices in this sector have a positive potential: sustainable approaches may save costs, increase revenues, reduce risks, develop human capital and improve access to capital (**Sustainability/IFC/Ethos, 2000**).

**Table-02.** Respondents' Awareness Regarding Sustainable Finance and its Various Dimensions:

SL	Specific Dimension	Mean Score	Rank
1	Generating revenues	4.53	4
2	Cost Savings	4.40	7.5
3	Risk Reducing	4.32	12
4	Addition to Capital/ Investment	4.50	5
Sl.	Specific Dimension	Mean Score	Rank
	<b>Economic Dimensions</b>		
5	Economic Value Added	4.42	6
6	Contribution to Govt. Exchequer	4.57	3
7	Competitive Advantage	4.20	21.5

<b>Social Dimensions</b>			
8	Customers' Satisfaction	4.60	1
9	Employees Welfare	4.58	2
10	Building Trust	4.30	13
11	Building Image	4.33	10
12	Community Interest	4.22	19
13	Publicity	4.23	17
14	Product/Service with reasonable charge	4.33	10
15	Brand Awareness	4.40	7.5
16	Ethical Responsibility	4.20	21.5
17	Legal Responsibility	4.22	19
<b>Environmental Dimensions</b>			
18	Emission of Carbons	4.27	14
19	Bio-gas Plan and Solar panel	4.25	15.5
20	Waste Management	4.33	10
21	Maintaining Ecological balance	4.25	15.5
22	Environmental Conservation	4.22	19

**Source:** Field Survey (Calculation made by researcher)

From the Table 2, it is seen that according to the awareness of owners tops 1st rank with 4.60 means score followed by employees welfare with 4.58 means score, contribution to government exchequer with 4.57 mean score, generating revenues with 4.53 mean scores, addition to capital/investment with 4.50 mean score, economic value added with 4.42 mean score and so on.

### **Beliefs and Attitudes of Respondents Regarding Sustainable Finance:**

In order to measure the perceptions of the respondents regarding sustainable finance, their awareness is not enough. The beliefs & attitudes of the respondents are also essential elements of perceptions. The following table-3 shows the levels of beliefs & attitudes of the respondents in case of various dimensions of sustainable finance.

**Table 3.** Showing Beliefs and Attitudes Dimensions on Sustainable Finance:

Sl.	Specific Dimension	Mean Score	Rank
1	Generating Revenues	4.50	3
2	Cost Savings	4.40	5
3	Risk Reducing	4.27	10
4	Addition to Capital/Investment	4.35	6
<b>Economic Dimensions</b>			
5	Economic Value Added	4.28	9
6	Contribution to Govt. Exchequer	4.43	4
7	Competitive Advantage	4.08	20.5
<b>Social Dimensions</b>			
8	Customers' Satisfaction	4.60	1
9	Employees Welfare	4.53	2
10	Building Trust	4.23	12.5
11	Building Image	4.25	11
12	Community Interest	4.17	18
13	Publicity	4.20	16
14	Product/Service with reasonable charge	4.33	7
15	Brand Awareness	4.30	8
16	Ethical Responsibility	4.08	20.5
17	Legal Responsibility	4.20	16
<b>Environmental Dimensions</b>			
18	Emission of Carbons	4.13	19
19	Bio-gas Plan and Solar panel	4.04	22
20	Waste Management	4.20	16
21	Maintaining Ecological balance	4.23	12.5
22	Environmental Conservation	4.22	14

**Source:** Field Survey (Calculation made by researcher)

From Table-3, it is observed that according to belief and attitudes of the owners, customers' satisfaction ranks first position with 4.60 mean score followed by employees' welfare with 4.53 mean score generating revenues with 4.50 mean score, contribution to exchequer with 4.43 mean score, cost savings with 4.40 mean score, addition to capital/investment with 4.35 mean score and so on. The table also depicts that in case of some dimensions of sustainable finance; beliefs & attitudes of clients have been higher and in case of some other dimensions beliefs & attitudes of

owners and bankers have been higher. The common feature of table-3 discloses that in case of most of the specific dimensions mean scores of owners & bankers seem to be higher than that of the clients.

#### ***Understanding of Respondents Regarding Dimensions of Sustainable Finance:***

It has been mentioned earlier that the perceptions include awareness, beliefs & attitudes as well as understanding. In table-4 the levels of understanding of the respondents' have been presented:

**Table 4.** Showing the Understanding on Dimensions of Sustainable Finance:

Sl.	Specific Dimension	Mean Score	Rank
1	Generating Revenues	4.53	2.5
2	Cost Savings	4.47	5
3	Risk Reducing	4.25	13.5
4	Addition to Capital/Investment	4.48	4
	<b>Economic Dimensions</b>		
5	Economic Value Added	4.08	20.5
6	Contribution to Govt. Exchequer	4.42	6
7	Competitive Advantage	4.13	18.5
	<b>Social Dimension</b>		
8	Customers' Satisfaction	4.58	1
9	Employees Welfare	4.53	2.5
10	Building Trust	4.23	16.5
11	Building Image	4.26	11
12	Community Interest	4.28	10
13	Publicity	4.30	9
14	Product/Service with reasonable charge	4.35	7
15	Brand Awareness	4.33	8
16	Ethical Responsibility	4.25	13.5
17	Legal responsibility	4.13	18.5
	<b>Environmental Dimension</b>		
18	Emission of Carbons	4.08	20.5
19	Bio-gas plan and Solar panel	4.00	22
20	Waste Management	4.25	13.5
21	Maintaining Ecological balance	4.25	13.5
22	Environmental Conservation	4.23	16.5

**Source:** Field Survey (Calculation made by researcher)

The Table 4 depicts that in terms of the owners and bankers, customers satisfaction also ranks with 4.58 mean score followed by employees' welfare and generating revenues with 4.53, mean score, addition to capital/investment with 4.48 mean score, cost savings with 4.47 mean score, contribution to govt. exchequer with 4.42 mean score, product/service with reasonable price with 4.35 mean score, brand awareness with 4.33 mean score and so forth. From the analyses made so far, it can be said that the levels of perceptions of most of the respondents of both

types have been very high from the viewpoints of their awareness, beliefs and attitudes and understandings in respect of the dimensions: i. Customers satisfactions ii. Employees' welfare iii. Contribution to govt. exchequer iv. Generating revenues v. Cost savings vi. Product/Service with reasonable charge vii. Brand awareness and viii. Addition to capital/investment. Again, the levels of perceptions of the majority respondents' have been high from the viewpoints of their awareness, beliefs, attitudes and understandings in respect of the dimensions: i. Economic value added

ii. Building image iii. Risk reducing iv. Building trust and v. Community interest

### **Impact of sustainable finance on bank performance**

Before measuring impact of sustainable finance, firstly, we are to examine the relationship of each of the independent variables namely, OI, TI, EVA, TD, IF, LP, LA, DR, ROC, CSRI, EWC, NOE and NCF with the dependent variable SE. The table i (Annex 1) shows the coefficients of such relationship. The table points out that coefficient of correlations (r) between OI and SE, TI and SE, EVA and SE, TD and SE, IF and SE, LP and SE, LA and SE, DR and SE, ROC and SE, CSRI and SE, EWC and SE, NOE and SE and NCF and SE have been found out as 0.144, -0.068, 0.301, 0.276, -0.101, 0.216, -0.109, 0.012, 0.080, 0.169, 0.432, 0.279 and 0.368 respectively. The table also reveals that (r) between SE & EVA, SE & TD, SE and TD, SE and LP, SE and EWC, SE and NOE and SE and NCF has been significant with 2 tailed at 1 percent and 5 percent levels. Thus it can be said that the variables: SE and EVA, SE and TD, SE and LP, SE and ROC, SE and EWC, SE and NOE, SE and NCF have been highly positively correlated. Thus, it is seen that there exists relationship between shareholders' equity representing value of the firm and each of the measures of sustainable finance.

The Table also reveals inter correlation between the independent variables. It revealed that in some cases namely EVA and TD, LP and TD, TI and ROC, EVA and NCF, TD and NCF, LP and NCF, LP and NOE, TD and NOE, TD and NOE, CSRI and ROC, NCF and NOE, there exist multi-collinearity problems since the value of (r) between those variables are found to be more than 0.70. As a result of the existence of such multi-collinearity problems, the value of R2 appears to be high, to some extent. The removal of those problems by dropping those variables from regression model would definitely produce accurate value of R2. In order to measure the impact of the independent variables on the dependent variable, the regression model as specified earlier has been applied. Taking un-standardized coefficients from Coefficient table-ii (Annex 1) the model has been estimated as follows:

$$SE = \beta_0 + \beta_1 OI + \beta_2 TI + \beta_3 EVA + \beta_4 TD + \beta_5 IF + \beta_6 LP + \beta_7 LA + \beta_8 DR + \beta_9 ROC + \beta_{10} CSRI + \beta_{11} EWC + \beta_{12} NOE + \beta_{13} NCF$$

$$= -15192.205 -0.003OI + 0.227TI + 0.080EVA + 0.055TD -1.266IF - 0.749LP - 0.012LA + 3158.099DR - 274.647ROC - 8894.066CSRI + 490.622EWC -0.873NOE + 1.385NCF$$

From the regression summary output, the beta-coefficient of TI, EVA, TD, DR, EWC & NCF tend to have positive impact on shareholders' equity. On the other hand, the beta coefficients of OI, IF, LP, LA, ROC, CSRI and NOE tend to have negative impact on shareholders' equity. Here, it is important to determine whether the independent variables' responsiveness is statistically significant or not. From the value of "t" statistics, it is seen that TI, IF, LP, CSRI, EWC and NCF have been significant at 1percent to 10 percent levels (Table iii, Annex 1).

The coefficient of multiple determinations, herein called R2 indicates that the regression model explains 41.6 percent of the variation of shareholders' equity and from the ANOVA table iv (Annex 1) it is evident that the model is at 0.000 level of significance. Thus, it can be said that the shareholders' equity (Value of Firm) has been influenced by the independent variables namely OI, TI, EVA, TD, IF, LP, LA, DR, DR, CSRI, EWC, NOE and NCF to the extent of 41.6 percent. As a result, it is observed that the hypothesis 4 - the measures of sustainable finance have impact on shareholders' equity- has been proved. Therefore, it can be concluded that the various indicators of sustainable finance have a great influence and role to play in the growth and development of Banking Industry in Bangladesh.

### **6.0 MAJOR CHALLENGES OF SUSTAINABLE FINANCE:**

The banking industry of Bangladesh has to face a number of challenges in order to achieve financial sustainability. Before identifying the major challenges, it is essential to identify the requirements for acquiring financial sustainability in any organization. Some authors (Leon, Patricia, 2001) have mentioned the following necessary requirements for obtaining financial sustainability. Such as long-term commitment, leadership, investment of time and money, business plan, effective management team, team work. Against the backdrop, the respondents' were asked to identify the major challenges hindering sustainable finance in their organizations. The Table 6 shows the responses in this regard.

**Table 5.** Showing the Major Challenges of Sustainable Finance:

Sl.	Specific factors	Mean Score	Rank
1	Operational Self insufficiency	4.50	2
2	Heavy default culture	4.53	1
3	Poor Corporate governance	4.40	3
4	Lack of adequate Accountability and Transparency	4.37	4
5	Environmental Pollutions	4.25	6
6	Lack of adequate legal responsibility	4.17	10.5
7	Lack of brand awareness	4.17	10.5
8	Ecological Imbalance	4.07	16.5
9	Poor Publicity	4.23	7
10	Lack of adequate ethical responsibility	4.03	18
11	Inadequate employees non- financial welfare	4.30	5
12	Flexibility of Repayment Schedule	4.08	15
13	Lack of cost consciousness	4.07	16.5
14	Inadequate number of borrowers	4.13	12
15	Poor Debt ratio	4.10	13.5
16	Low Debt-equity ratio	3.93	20
17	Low Operational Efficiency	4.22	8
18	Lower competitive advantage	4.10	13.5
19	Excessive Loan Disbursement	4.00	19
20	Improper Appraisal of Loan Applications	4.20	9

**Source:** Field Survey (Calculation made by researcher)

The analysis of Table 5 reveals that the heavy default culture has been identified as the number one challenge having 4.53 mean score followed by operational self-insufficiency with 4.50 mean score and, poor corporate governance with 4.40 mean score, lack of adequate accountability and transparency with 4.37 mean score, inadequate employees' nonfinancial welfare with 4.30 mean score, environmental pollutions with 4.25 mean score, low operational efficiency with 4.22 mean score, improper appraisal of loan applications with 4.20 mean score, lack of brand awareness with 4.17 mean score, inadequate number of borrowers, with 4.13 mean score, and so on.

## 7.0 CONCLUSION

Sustainable finance is one of the most significant prerequisites for the growth and development of any organization, especially banks and financial institutions. Since, the banks deal in public money, the public confidence is essential for smooth running and growth-development of the banks. The public confidence grows in case of such banks whose sustainable finance is remarkable. This study has pointed out that the growth-development of the sample banks, measured in terms of shareholders' equity have been influenced to the extent of

41.6 percent by the sustainable finance oriented independent variables. As a result, the improvement of the existing positions of the variables would definitely lead to increase shareholders' equity in cases of sample banks which in turn, would ensure the smooth growth-development of the banks. Therefore, the interest groups mainly the management of the sample banks should take all possible measures to remove the challenges adversely affecting the sustainable finance. To this end, the suggestions provided by the respondents as mentioned in the study need to be implemented by the relevant authorities without any further delay.

The study is not beyond any limitations, rather it has some limitations. Firstly, the study was limited to only 20 commercial banks out of a total number of 47 operating in the county. Secondly, since, the sample banks have been limited; the number of respondents was limited too. The chief reason for limiting the study was the time and resource constraints at the disposal of the researchers. Thirdly, the desired types of secondary data were not readily available in the published sources such as annual reports; annual accounts statements etc. of the sample banks. The requisite data had to be converted by the researchers themselves for the meaningful use in this study. In spite of these limitations, the outcomes of this study,

however, may be the representative of the banking industry of the country.

## References:

- [1] Adongo, J., and Stork, C. (2006). Factors influencing the financial sustainability of selected microfinance institutions in Namibia (No. 39). Namibian Economic Policy Research Unit.
- [2] Anwarul Islam, K. M., and Zaman, M. (2013). An Empirical Study on Effect of Productivity on Profitability in Some Selected Private Commercial Banks (PCBs) in Bangladesh. *International Journal of Economics and Finance*, 5(12), 151-162.
- [3] Eke, O. P., and Olokoyo, F. O. (2017). Global Financial Crisis and its Ramifications on Capital Markets, *Contributions to Economics*.
- [4] Khaleq et al. (1995) *Research Procedure in Social Science*, Hasan Book House, Dhaka, P-205
- [5] Kinde, B. A. (2012). Financial sustainability of microfinance institutions (MFIs) in Ethiopia. *European Journal of Business and Management*, 4(15), 1-11.
- [6] León, Patricia. 2001. *Four Pillars of Financial Sustainability. Resources for Success Series. Volume 2*. Arlington, VA, USA: The Nature Conservancy.
- [7] Pelozo, J., and Yachnin, R. (2008). *Valuing business sustainability:*

A systematic review. Research Network for Business Sustainability Knowledge Project Series.

- [8] Rahman, A. (1996). Micro-credit initiatives for equitable and sustainable development: who pays? A case study of the Grameen Bank Program in rural Bangladesh.
- [9] Rai, A. K., and Rai, S. (2012). Factors affecting financial sustainability of microfinance institutions. *Journal of Economics and Sustainable Development*, 3(6), 1-9.
- [10] Solaiman and Azad (2009), *Sustainable Development in Bangladesh Perspective, The Cost and Management*, Journal of ICMAB, P-25
- [11] Soppe, A. (2004). Sustainable corporate finance. *Journal of Business Ethics*, 53(1-2), 213-224.
- [12] Sultana, N. and Akter, A. (2015) "Factors influencing the sustainability of private commercial banks in Bangladesh", proceedings of the 13th SAMF international conference in Colombo, Srilanka, 2015, AMDISA & ICPM, Srilanka, pp. 170-179.
- [13] Sustainability (2002) /IFC/Ethos, *Developing Value. The business case for sustainability in emerging markets*, p. 4, <http://www.sustainability.com/library/developing-value>; similarly based on case studies,
- [14] Vijfvinkel, S., Bouman, N., and Hessels, J. (2011). *Environmental sustainability and financial performance of SMEs*. EIM Research Reports.

## Appendix-1

**Table i: Pearson correlation matrix**

	SE	OI	TI	EVA	TD	IF	LP	LA	DR	ROC	CSRI	EWC	NOE	NCF
SE	1.00													
OI	0.321**	1.00												
TI	-0.07	0.13 2*	1.00											
EVA	0.301**	0.353**	0.07	1.00										
TD	0.276**	0.44**	0.212*	0.80	1.00									
IF	-0.10	0.12	-0.20	0.36 4**	0.19 9*	1.00								
LP	0.216**	0.32 1**	0.30 4**	0.61 4**	0.81 5**	0.04	1.00							
LA	-0.02	0.09	-.34 6**	0.13	0.02	0.55 8**	0.34 2*	1.00						
DR	0.01	-0.08	-0.12	-0.09	-.30 4**	0.36 2**	- .234*	0.22 8*	1.00					
ROC	0.08*	0.16	0.80 4**	0.31 8**	0.47 4**	-.23 0*	0.57 1*	-.588*	0.17	1.00				
CSRI	0.17	0.25 2*	0.61 5**	0.44 0**	0.67 6**	0.04	0.02	0.17 2**	0.17	0.11	1.00			
EWC	0.432**	0.21 5*	0.15	0.35 4**	0.28 7**	0.02	0.36 8*	-.58 8*	0.26	0.25 1*	0.41 9**	1.00		
NOE	0.279**	0.27 7**	0.04	0.34 4**	0.83 1**	0.12	0.72 8*	.17 2**	0.03	0.37 1**	0.44 2**	0.39 3**	1.00	
NCF	0.368**	0.30 5**	0.09 9*	0.82 8**	0.72	0.91 4*	0.36 8*	-.58 8*	.499*	0.57 9**	0.32 5*	0.499*	0.57 9**	1.00

**Note:** \*\*Coreelation is significant at 0.01 level, \* Coreelation is significant at 0.05 level



**Table ii: Coefficients**

Model	Unstandarized Coefficients	Std. Error	Standarized Coefficients	t	Sig.
	B.		Beta		
Constant	15192.205	4600.235		-3.302	.001
OI	-.003	.022	-.014	-.134	.894
TI	.227	.124	.483	1.829	.071
EVA	.080	.554	.024	.144	.886
TD	.055	.086	.320	.636	.526
IF	-1.266	.730	-.214	-1.734	.086
LP	-.749	.222	-.866	-3.371	.001
LA	-.012	.068	-.037	-.184	.855
DR	3158.099	2470.852	.163	1.278	.205
ROC	-274.647	209.486	-.404	-1.311	.193
CSRI	-8894.006	4825.407	-.403	-1.843	.069
EWC	490.622	123.541	.484	3.971	.000
NOE	-.873	.629	-.258	-1.387	.169
NCF	1.385	.392	1.307	3.538	.001

a. Dependent Variable: SE

**Table-iii: Model Summary**

Model	R	R Square	Adjusted R Square	Std. Error the Estimate
1	.645a	.416	.328	6077.9911198

a. Predictors: (Constant), NCF, IF, TI, EWC, OI, DR , LA, EVA, NOE, CSRI, LP, ROC, TD

**Table-iv: ANOVA<sub>a</sub>**

Model	Sum of Squares	df	Mean Square	F	Sig.
Regression	2264096533.172	13	174161271.782	4.714	.000 <sub>b</sub>
Residual	3177009940.484	86	36941976.052		
Total	5441106473.65	99			

a. Dependent Variable: SE

b. Predictors: (Constant), NCF, IF, TI, EWC, OI, DR , LA, EVA, NOE, CSRI, LP, ROC, TD

# LOCAL RESIDENT'S ATTITUDES TOWARDS THE IMPACT OF TOURISM DEVELOPMENT: A STUDY OF SAINT MARTIN ISLAND, BANGLADESH

**Masum Miah<sup>(1)</sup> and Mst. Jannatul Mawa<sup>(2)</sup>**

1. Assistant Professor, Department of Business Administration and chairman (acting)

Department of Tourism and Hospitality Management

Noakhali Science and Technology University, Noakhali-3814, Bangladesh.

E-mail: masum7cu@gmail.com

2. Assistant Professor, Department of Tourism and Hospitality Management

Noakhali Science and Technology University, Noakhali-3814, Bangladesh

E-mail: orin7860@gmail.com

## ABSTRACT

The purpose of this study is to determine the local residents' attitudes of tourism development of Saint Martin Island. This research analyzes resident's perceptions and attitudes of the impact of tourism development and examines the factors that influence the support for tourism development of Saint Martin Island, Bangladesh. To this end, a survey was administered among 150 respondents who were local residents of Saint Martin Island, using a type of non-probability sampling that is convenience sampling technique. Following data collection from a questionnaire, factor analysis, correlation and regression analyses were conducted. Four factors (economic impacts, socio-cultural impacts, environmental impacts, physical impacts) emerged and these all four factors are interrelated and highly influential local resident's attitudes towards tourism development. Additionally, it is evident from the beta coefficient of multiple regression analysis that economic impacts had significant positive influence on tourism development whereas socio-cultural, environmental and physical impacts had negative impacts on tourism development in the region.

**Key words:** Local residents, residents' attitudes, tourism development, impacts

## 1.0 INTRODUCTION

St. Martin's Island is not only significant for its biodiversity value, but also important for Bangladesh in defining its Exclusive Economic Zone (EEZ) and outlining its sea boundary in accordance with the United Nations Convention on the Law of the Sea. St. Martin's Island is a very small island in the Bay of Bengal and is located at 20034' - 20038N and 92018' - 92022'E, the southernmost slant of Bangladesh separated from the mainland by a channel which is about 9 km wide and 10 km south of the southern tilt of Teknaf peninsula and 34 kilometers from Teknaf mainland in Cox's Bazar district of Bangladesh (Islam, 2002). This is the only island in Bangladesh which has coral colonies in the shallows. Enormous areas of sand ridge, some mangrove formations, Pandanus

vegetation and scattered boulder/dead corals are the major characteristics of this island. Coconut Palm *Cocosnucifera* (locally called Narikel) is abundantly cultivated on the Island and has given the Bangla name of St. Martin's - Narikel Jhinjira. There is no electricity on the island except some hotels/resorts though the larger hotels run generators in the evenings for a few hours. November to February is the main tourist season with the best weather. Corals and clear blue water have helped Bangladesh's only coral island becomes a major tourist attraction. Now, more than 3,000 tourists (Haider, 2008) arrive every day and they are staying there at night. St. Martin's Island in the Bay of Bengal attracts thousands of local and foreign visitors every day thanks to its charming beauty and clean and tidy marine life. Local authorities recently introduced scuba diving

and speedboat sailing to attract more tourists, and there are plans to bring water skiing and other sporting facilities to the island. The major threats to the coral habitats are high levels of sedimentation, cyclones, storm surges, freshwater and agricultural runoff, pollution from human settlements and the removal of coastal vegetation (Rajasurya and others, 2000). The main threat to future viability of coral communities comes from direct extraction of corals colonies. Coral collection activities started in 50's but until recently extraction was at low level. Large-scale removal of coral boulders and dredging of channels has caused considerable damage to the reefs, and a barrier wall built on the sea front has caused beach erosion (Mollah). The removal of Pandanus trees for firewood has also caused much beach and dune erosion (Rajasurya and others, 2000). Pollution from both land based and vessel based Sewage, oil and grease, garbage and uncleaned water are among the long-standing pollution problems that can have significant negative effects on coral reefs system. Local people are roughly engaged in fishing as main bread and butter that hampers the sea biodiversity. According to local elders, 10-15 years ago, turtle nesting was very common on most of the beaches. Endless over-exploitation has brought the nesting turtles to near extinction. Tourism has been increased deliberately in the Saint Martin Island over the last few years and for this reason tourism related activities have also been increased which is posing threat to this special type of island and its biodiversity. The ecosystem on the island is not well equipped to manage itself. Tourists have been found in illegal activities such as stealing live corals and other lives for souvenirs, fishing within the marine protected areas. Moreover, natural and other anthropogenic activities also put the island at stake in respect of biodiversity. Concerned bodies must observe the impact of tourism on the island's biodiversity and have to take necessary steps for the conservation of biodiversity. Initiatives should be taken immediately to integrate tourism management into biodiversity conservation in the island. Local people are very unaware about the importance of sustainable tourism or eco-tourism. They always thought about their economic benefits, not about environment preservation and conservation.

## 2.0 OBJECTIVES

- ❖ To determine attitude of local residents towards economic, socio –cultural, environmental and physical impacts of tourism.
- ❖ To observe the relationships between residents' demographic attributes and their attitude toward impacts of tourism development.

## 3.0 LITERATURE REVIEW

Many regions, like Saint Martin Island, were facing real problems caused by mass tourism. Researchers have identified three types of impacts: economic, social and environmental. These impacts can be positive, negative or both at the same time (Fennel, 2007; Mason, 2003; Saarinen, 2007). On one side, the positive impacts may consist of: income for the local community, employment in the service industry, the increased infrastructure (economic), learning and sharing between cultures, increased quality of life, upholding the flag of new and enhanced global community (socio-cultural) and conservation of areas/countryside (environmental). Tourism development contributes to conservation of biodiversity, sustains the well -being of local people, involves responsible action on the part of tourist and the tourism industry, promotes small and medium tourism enterprises, requires lowest possible consumption of natural resources, stresses local participation, ownership, and business opportunities, particularly for rural people and above all includes the learning experiences (Kiper, 2011). Now, more than 3,000 tourists (Haider, 2008) arrive every day and they are staying there at night. St. Martin's Island in the Bay of Bengal attracts thousands of local and foreign visitors every day thanks to its charming beauty and clean and tidy marine life. Local authorities recently introduced scuba diving and speedboat sailing to attract more tourists, and there are plans to bring water skiing and other sporting facilities to the island. Tourism also causes a change in local resident's habits, daily routines, social lives, beliefs, and values. According to WTO (1996), the indicators measure the information and through which decisions makers could reduce the chances of making the wrong decisions. Although in theory it sounds well-designed, the strategy for sustainable tourism based upon the indicators is complicated due to the selection process, the measurement, monitoring and evaluation of the set of relevant variables. Puczkó

and Rátz (2000) have emphasized about unplanned tourism development that can lead to a negative change in destinations' socio-cultural and physical characteristics. There have been several other factors identified as influencing residents' attitudes toward tourism such as age (Tomljenovic and Faulkner 1999; Cavus and Tanrisevdi, 2003; McGehee and Andereck, 2004; Pappas, 2008), education (Iroegbu and Chen, 2001), gender (Mason and Cheyne, 2000; Harrill and Potts, 2003; Pappas, 2008), income (Snaith and Haley, 1994; Pappas, 2008), community attachment (Lankford and Howard, 1994; McCool and Martin, 1994; Snaith and Haley, 1994), economic role of tourism (Andereck, et al., 2005; Huh and Vogt, 2008), economic reliance on tourism (Madrigal, 1995; McGehee and Andereck, 2004), involvement in decision making (Madrigal, 1995; Kayat, 2002), knowledge about tourism (Lankford and Howard, 1994; Andereck, et al., 2005), length of tourist stay (McGehee and Andereck, 2004) and personal benefits from tourism (McGehee and Andereck, 2004; Andereck, et al., 2005). Tourism also plays an important role in social and cultural preservation, rejuvenation of traditional culture and promotion of indigenous arts and crafts industries in the region. On the other hand, some studies have identified certain concerns regarding loss of traditional cultures and values, increase in crime, drugs and alcohol abuse, sudden hike in the cost of accommodation and the waiting time to deliver services (Haralambopoulos and Pizam 1996; Andereck et al. 2005; Martin 2008; Diedrich and Garcia -Buades 2009). Therefore it is imperative to recognize stakeholders when managing tourism more sustainably and to take account of their different perspectives on the issues (Bramwell, Henry, Jackson, & Van der Straaten, 1996; Dodds, 2007; Hardy & Beeton, 2001). Stakeholders should not only be recipients of Sustainable Tourism Plans but active participants in the planning process (Byrd, 2003; Southgate & Sharpley, 2002). Many authors contend that the problem of implementing Sustainable Tourism lies in its practical application and in the complexity of its parental paradigm (e.g. Dewhurst & Thomas, 2003; Hardy et al., 2002; Harris, Griffin, & Williams, 2002; Sharpley, 2000). The various terms that are assumed to be synonymous with sustainable tourism as well as community based tourism and their alternative approaches to tourism development have been controversial (Butler, 1990; Hunter & Green, 1995; Mow forth & Munt, 1998; Pforr, 2001; Wheeler, 1991).

## 4.0 METHODOLOGY

### 4.1 Type of Study

The study is basically descriptive in nature. According to Best and Kahn (1998), descriptive study interprets the situations, conditions or relations as it exists. They also elaborated that descriptive study deals with the relationships between variables, tests hypotheses and develops principles, theories and generalizations having universal validity.

### 4.2 Area & Data Sources

In order to achieve the objectives and to test hypotheses, both primary and secondary data were gathered. The literature review part of the report is mainly based on secondary data which was gathered from the published books, different published research works, newspaper, and magazines, reports of various government authorities, and websites and journals. Primary data have been collected from the residents of Saint Martin Island through a questionnaire. A visit has been also conducted by the author during the period From 20 October, 2018 to 22 February, 2019 to collect the relevant information to find out the attitude of local residents towards economic, socio-cultural, environmental and physical impacts of tourism development of Saint Martin Island.

### 4.2 Instruments

For scaling purpose, the 5-point Likert Scale of the itemized rating scale (Noncomparative Scaling) has been used. Respondents were asked to rate 20 items. These 20 items have been scored on a 5-point Likert scale, ranging from 1=strongly agree to 5=strongly disagree.

### 4.3 Sample Size, Sampling Technique and Data Collection Procedure

A total number of 150 samples have been taken on the basis of convenience sampling technique. They were informed of the purpose of the study and were requested to read the instructions attentively and respond to the items accordingly. Finally, total sample size contained 150 whereas 106 (34.6%) respondents were male and 44 (14.4%) respondents were female.

### 5.0 CONCEPTUAL MODEL

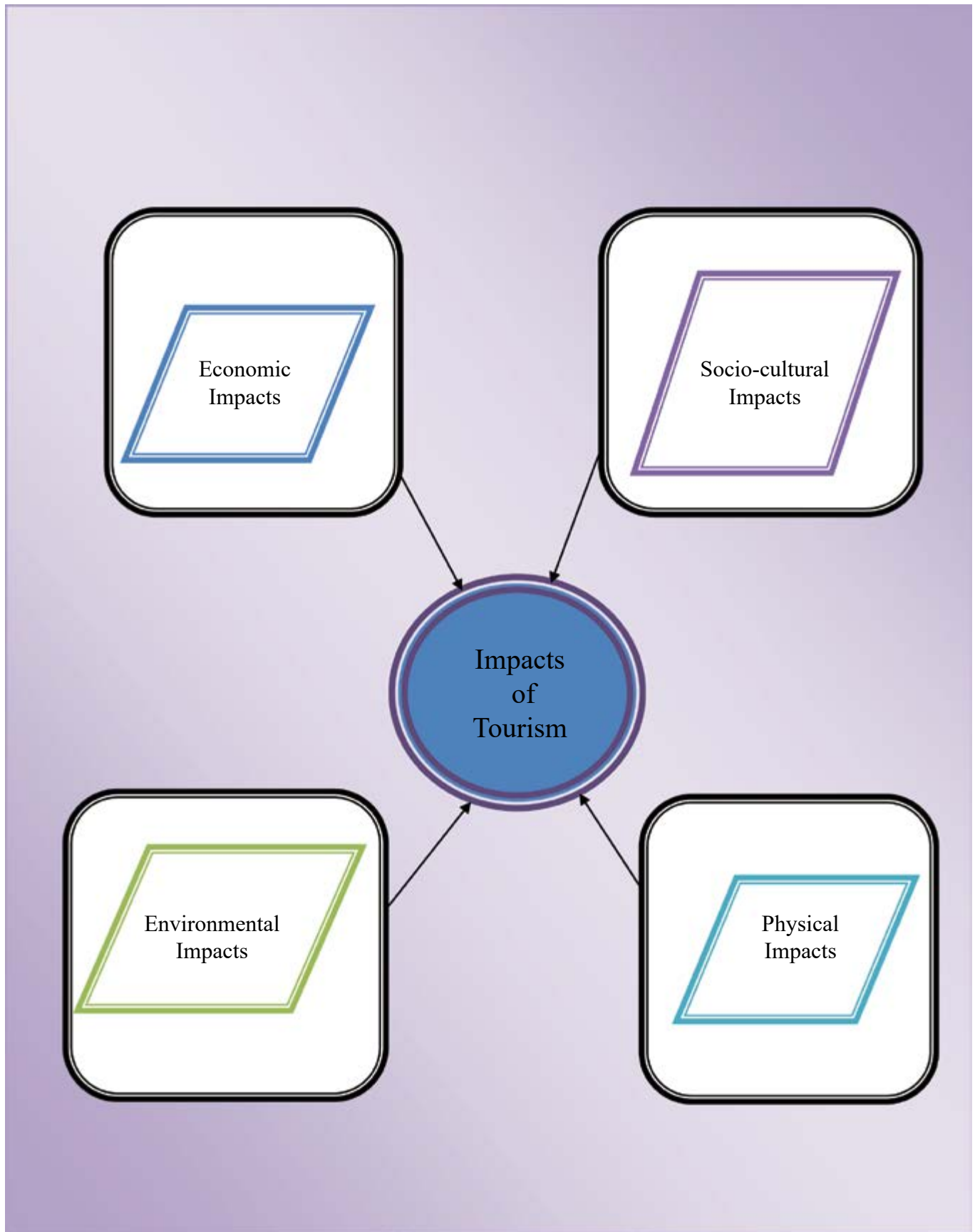

**Fig 1.** A Proposed Model of Impacts of Tourism Development

## 6.0 APPROACH TO THE PROBLEM

### 6.1. Analytical Model (Mathematical)

#### For the Factor Analysis:

$$F_i = W_{i1}X_1 + W_{i2}X_2 + W_{i3}X_3 + \dots + W_{ik}X_k$$

Where,

$F_i$  = Estimate of the  $i$ th factor

$W_i$  = Weight or factor score coefficient

$K$  = Number of variables

I1= Interaction between tourists and hosts	I2= Damage natural environment and landscape	I3= Infrastructural facilities (supply of water. sewage. electric etc.)	I4= Proper preservation and conservation
I5= Diversify the local economy	I6= Income and standard of living increased	I7=Beneficiary of local by Community participation training	I8= Degradation of environmental sustainability
I9= Expenditures increased	I10= change in local traditional life style	I11= Poor payment of locals by the tourism business operators	I12= Poor Shopping facilities for tourists
I13= Opportunities for new markets of local products ( sea fish, dry fish, Barmiz Products)	I14= Poor quality of local services as well as recreational and entertainment facilities	I15= Unauthorized buildings and hotels/ resorts planning	I16= Social problems (crime, gambling, unauthorized drug selling, stealing live corals, fishing within the marine protected areas)
I17= Authenticity of locals lifestyles diminished	I18= Part time jobs due to seasonal in nature	I19= Pollution increased	I20=Destruction of environment due to constructing excessive tourists facilities

#### For the Regression Analysis:

$$Y = a + b_1i_1 + b_2i_2 + b_3i_3 + \dots + b_ki_k$$

Where,

$Y$  = Dependent or Criterion Variable

$x$  = Independent or Predictor Variable

$a$  = Intercept of the Line

$b_1$  = Slope of the Line

### 6.2. Hypothesis and Data Analysis Tools

For the quantitative analysis, the following hypothesis has been developed:

#### Hypothesis-1:

**H0:** There are no correlations among the set of identified factors of tourism development impacts at Saint Martin Island that measure local resident's attitudes that means twenty (20) identified variables are uncorrelated.

**H1:** The variables are highly correlated.

#### Hypothesis-2:

**H0:** No relationship exists among the dependent variable (local resident's attitudes) and the independent variables (obtained uncorrelated factors, i.e. economic impacts, socio-cultural impacts, environmental impacts and physical impacts) that measure local resident's attitudes.



**H1:** There is relationship among local resident's attitudes at Saint martin Island towards tourism development impacts and obtained uncorrelated factors. The final analysis has been performed by using different statistical techniques, namely factor analysis, correlation, multiple regression and descriptive statistics via SPSS Statistics V25.0 package program.

## 7.0 ANALYSIS AND INTERPRETATION OF RESULTS

### 7.1. Factor Analysis

There were twenty (20) variables, most of which are correlated and which must be reduced to a manageable level. By using factor analysis, the whole set of interdependent relationships among variables have been examined. Using varimax rotation, twenty (20) variables are reduced into four (4) uncorrelated factors having Eigen Value greater than 1.0. Principle Component Analysis has been selected to determine the minimum number of factors that will account for maximum variance in the data for use in subsequent multivariate analysis.

#### 7.1.1. Testing Hypothesis-1: KMO and Bartlett's Test

The null hypothesis, that the twenty (20) variables are uncorrelated is rejected by the Barlett's test of sphericity (**Table 1**). A large value of the test statistic favors the rejection of the null hypothesis. From the table, it has been found that the approximate chi-square statistics is 2608.034 with 190 degrees of freedom which is significant at .05 levels. Besides, high values (between .5 and 1.0) of KMO measure of sampling adequacy indicate that the factor analysis is appropriate. Here, as the value of the KMO statistic (**Table 1**) is .756, the factor analysis is considered an approximate technique for analyzing the data.

#### Testing Hypothesis-1: KMO and Bartlett's Test

Table 1. KMO and Bartlett's Test		
Kaiser-Meyer-Olkin Measure of Sampling Adequacy.		.756
Bartlett's Test of Sphericity	Approx. Chi-Square	2608.034
	df	190
	Sig.	.000

### 7.1.2 Initial Eigen values and Extraction Sums of Squared Loadings

The Eigen value for a factor indicates the total variance attributed to the factor. The total variance accounted by all the twenty (20) variables is 20, which is equal to the number of variables. Factor 1 account for a variance of 6.656, which is  $(6.656 / 20)$  or 33.281 % of the total variance. Likewise the next three factors  $(3.818/20)$ ,  $(2.135/20)$ ,  $(1.760/20)$  account for of the total variance respectively. Here the first three (3) factors combined account for 19.089 %, 10.673% and 8.802 % of the total variance. Here, the first four factors combined account for 71.844% of the total variance. The 'Extraction Sums of Square Loadings' shows the variances associated with the factors that are retained. These are the same as under 'Initial Eigen Values'.

**Table 2.** Initial Eigen values and Extraction Sums of Squared Loadings

Component	Total Variance Explained								
	Initial Eigenvalues			Extraction Sums of Squared Loadings			Rotation Sums of Squared Loadings		
	Total	% of Variance	Cumulative %	Total	% of Variance	Cumulative %	Total	% of Variance	Cumulative %
1	6.656	33.281	33.281	6.656	33.281	33.281	5.922	29.610	29.610
2	3.818	19.089	52.370	3.818	19.089	52.370	3.562	17.810	47.421
3	2.135	10.673	63.043	2.135	10.673	63.043	2.867	14.336	61.756
4	1.760	8.802	71.844	1.760	8.802	71.844	2.018	10.088	71.844
5	.865	4.325	76.170						
6	.825	4.127	80.297						
7	.740	3.701	83.997						
8	.684	3.418	87.415						
9	.577	2.883	90.298						
10	.401	2.003	92.301						
11	.312	1.559	93.860						
12	.272	1.358	95.218						
13	.212	1.062	96.279						
14	.186	.931	97.211						
15	.145	.727	97.938						
16	.123	.614	98.552						
17	.102	.511	99.063						
18	.083	.416	99.479						
19	.069	.343	99.822						
20	.036	.178	100.000						

Extraction Method: Principal Component Analysis.

**7.1.3 Determining the Number of Factors**

The numbers of factors have been determined based on several considerations: (i) Eigen Value (only four (4) factors with Eigen values greater than 1.0 are retained, [Table 2]); (ii) Scree plot ( the plot [Fig. 2] has a distinct break ( at four factors between the

step slope of factors, with large Eigen values and gradual trailing off (Scree) associated with the rest of the factors); (iii) percentage of variance ( the factors extracted should account for at least 60% of the variance and here, the first four (4) factors account for **71.844%** of the total variance [ Table 2]).

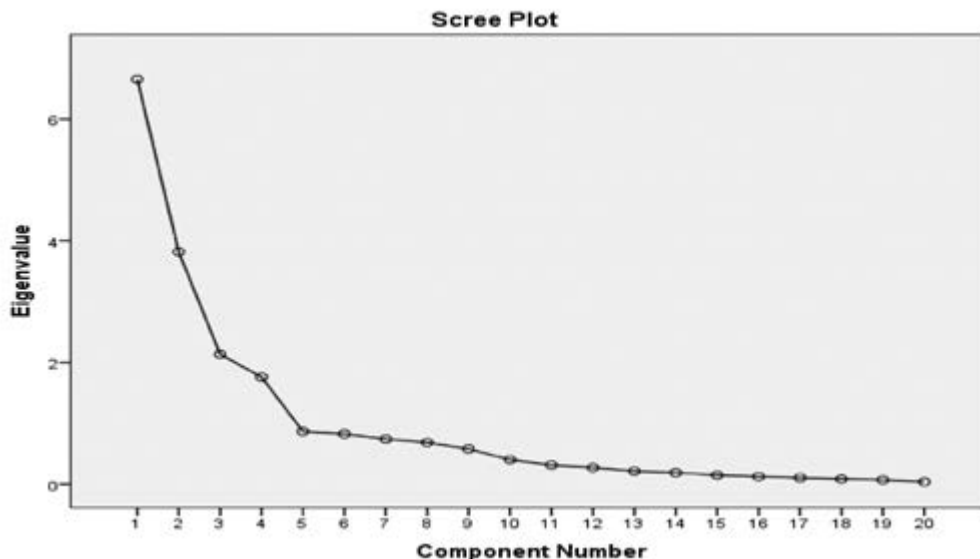

**Fig. 2.** Scree Plot

### 7.1.4 Rotated Component Matrix

<b>Table 3. Rotated Component Matrix<sup>a</sup></b>				
	Componen			
	1	2	3	4
I1	.347	-.839	.128	.096
I2	-.108	-.325	-.667	-.367
I3	.016	-.082	-.074	.882
I4	-.140	.138	.528	-.473
I5	.819	-.064	.171	-.155
I6	.570	.496	-.236	-.070
I7	.862	-.186	.056	.169
I8	-.313	.230	-.716	.092
I9	-.531	.310	-.023	-.567
I10	-.446	.590	.115	.092
I11	-.700	.017	-.254	-.143
I12	.881	.068	.189	.110
I13	.820	.067	.114	.175
I14	-.813	.128	-.046	.204
I15	.245	.464	.186	.683
I16	.159	.849	.216	-.125
I17	.189	-.866	.242	.207
I18	.831	-.123	-.137	.290
I19	.038	.196	.801	.213
I20	.196	.423	.768	.242
Extraction Method: Principal Component Analysis.				
Rotation Method: Varimax with Kaiser Normalization.				
a. Rotation converged in 7 iterations.				

A seven (4) factor solution resulted from the 32 variables, with the factors being labeled as:

1.	<b>Economic Impacts (I1)</b>	I5= Diversify the local economy, I6= Income and standard of living increased, I7=Beneficiary of local by Community participation training, I9= Expenditures increased, I11= Poor payment of locals by the tourism business operators, I12= Poor Shopping facilities for tourists, Opportunities for new markets of local products ( sea fish, dry fish, coral made products, Barmiz Products), I14= Poor quality of local services as well as recreational and entertainment facilities, I18= Part time jobs due to seasonal in nature.
2.	<b>Socio-cultural Impacts (I2)</b>	I1= Interaction between tourists and hosts, I10= change in local traditional life style, I16= Social problems (crime, gambling, unauthorized drug selling), I17= Authenticity of locals lifestyles diminished.
3.	<b>Environmental Impacts (I3)</b>	I2= Damage natural environment and landscape, I4= Proper preservation and conservation, I8= Degradation of environmental sustainability, I19= Pollution increased, I20=Destruction of environment due to constructing excessive tourists facilities (hotels, resorts, restaurants, generator supply for current and water availability)
4.	<b>Physical Impacts (I4)</b>	I3= Infrastructural facilities (supply of water. sewage. electric etc.), I15= Unauthorized buildings and hotels/ resorts planning

### 7.1.5 Correlation

The study has attempted to investigate the influential impacts factors of tourism development of Saint Martin Island that measure local resident's attitudes. For this reason, the Pearson Moment correlation has been applied in determining the association of each variable. The results are shown in the following table:

		<b>Economic Impacts</b>	<b>Socio-cultural Impacts</b>	<b>Environmental Impacts</b>	<b>Physical Impacts</b>
Economic Impacts	Pearson Correlation	1	.000	.000	.000
	Sig. (2-tailed)		1.000	1.000	1.000
	Sum of Squares and Cross-products	149.000	.000	.000	.000
	Covariance	1.000	.000	.000	.000
	N	150	150	150	150
Socio-cultural Impacts	Pearson Correlation	.000	1	.000	.000
	Sig. (2-tailed)	1.000		1.000	1.000
	Sum of Squares and Cross-products	.000	149.000	.000	.000
	Covariance	.000	1.000	.000	.000
	N	150	150	150	150
Environmental Impacts	Pearson Correlation	.000	.000	1	.000
	Sig. (2-tailed)	1.000	1.000		1.000
	Sum of Squares and Cross-products	.000	.000	149.000	.000
	Covariance	.000	.000	1.000	.000
	N	150	150	150	150
Physical Impacts	Pearson Correlation	.000	.000	.000	1
	Sig. (2-tailed)	1.000	1.000	1.000	
	Sum of Squares and Cross-products	.000	.000	.000	149.000
	Covariance	.000	.000	.000	1.000
	N	150	150	150	150

### 7.2. Regression Analysis

The four (4) factors that have been identified from the factor analysis are used as independent variables (metric) in the regression analysis and the dependent variable (metric) is local resident's attitudes. In

order to examine the predictability of local resident's attitudes towards the impacts of tourism development of Saint Martin Island, multiple regression analysis has been administered. The results are presented in the following table:

**Table 5.** Model Summary & ANOVA (b)

Model Summary									
Model	R	R Square	Adjusted R Square	Std. Error of the Estimate	Change Statistics				
					R Square Change	F Change	df1	df2	Sig. F Change
1	.836	.699	.690	.61220	.699	84.000	4	145	.000
<b>a. Predictors: (Constant), Economic Impacts, Socio-Cultural Impacts, Environmental Impacts And Physical Impacts</b>									
ANOVA									
Model		Sum of Squares	df	Mean Square	F	Sig.			
1	Regression	125.929	4	31.482	84.000	.000 <sup>b</sup>			
	Residual	54.344	145	.375					
	Total	180.273	149						
<b>a. Dependent Variable: Local Residents Attitudes</b>									
<b>b. Predictors: (Constant), Economic Impacts, Socio-Cultural Impacts, Environmental Impacts And Physical Impacts</b>									

### 7.2.1. Strength of Association

Model summary (Table-5) shows that, the multiple correlation coefficients, R is .836a. That means there are significant positive relationship existing among dependent and independent variables. So local resident's attitudes are highly correlated with the identified predictors (Economic Impacts (I1), Socio-Cultural Impacts (I2), and Environmental Impacts (I3) And Physical Impacts (I4)). The strength of association in multiple regressions is measured by the coefficient of multiple determination, R Square is .699 that means 69% of the local resident's attitudes is influenced by the impact factors of tourism development of Saint Martin Island which is accounted for by the variation in economic impacts, socio-cultural impacts, environmental impacts and physical impacts. It is then adjusted for the number of independent variables and the sample size to account for diminishing returns and the Adjusted R Square is .478 and Standard Error of the Estimate is .690. The value of Adjusted R Square is close to R Square. This suggests that all the independent variables make a contribution in explaining in local resident's attitudes.

### 7.2.2 Testing Hypothesis-2

#### 7.2.2.1 Significance of the Overall Regression Equation (ANOVA (b))

The F test is used to test null hypothesis for the overall test that the coefficient of multiple determination in the population, R square (pop) = 0. Here R square=.699 which means that the null hypothesis can be rejected. This is equivalent to testing the null hypothesis:  $H_0: \beta_1 = \beta_2 = \beta_3 = \beta_4 = \beta_5 = \beta_6 = 0$ . Analysis of variance (Table-5) shows that the overall test is conducted by using an F statistic where,  $F = 84.000$  which means the relationship is significant at  $\alpha = .05$  level with 4 and 145 degrees of freedom.  $\beta$ 's value associated with each of the independent variables for the model is not same and that means the null hypothesis can be rejected. So, it can be concluded that local resident's attitudes towards tourism development can be explained by economic impacts, socio-cultural impacts, environmental impacts and physical impacts. The explained variables have varying level of influences on forming that have positive or negative impacts on local resident's attitudes towards tourism development of Saint Martin Island.

### 7.2.2.2 Significance of the Partial Coefficients (Coefficients (a))

**Table 6.** Significance of the Partial Coefficients (Coefficients (a))

Coefficients						
Model		Unstandardized Coefficients		Standardized Coefficients	t	Sig.
		B	Std. Error	Beta		
1	<b>(Constant)</b>	2.313	.050		46.280	.000
	<b>Economic Impacts</b>	.695	.050	.631	13.848	.000
	<b>Socio-Cultural Impacts</b>	-.224	.050	-.204	-4.468	.000
	<b>Environmental Impacts</b>	-.506	.050	-.460	-10.079	.000
	<b>Physical Impacts</b>	-.239	.050	-.217	-4.762	.000
<b>a. Dependent Variable: Local Residents Attitudes</b>						

The above table presents the regression coefficient of independent variables. Analysis of coefficient shows which independent variables have a significant relationship with the dependent variable as well as the importance of each independent variable. Analysis of the coefficient suggests that impact factors of tourism development of Saint Martin Island such as economic impacts, socio-cultural impacts, environmental impacts and physical impacts have a strong influence on local resident's attitudes of Saint Martin Island.

To determine which specific coefficients ( $\beta$ 's) are nonzero, the significance of the partial coefficient for all the variables is tested by t-statistics (Table 6). The partial regression coefficient for economic impacts (I1) is .695. The corresponding beta coefficient is .631. The value t statistics,  $t = 13.848$ , with 145 degrees of freedom which is significant at  $\alpha = 0.05$ . so from this results, we can see that local residents of Saint Martin Island perceived that tourism is an important factor for the economic development of the area which helps to diversify the local economy that help to improve local standard of living as well as income is also increasing. Moreover, tourism helps to increases number of part time jobs (such as boatman, cycle renter, housekeeper, waiters, tour guide, restaurant manager, photographer, doorkeeper, etc.) due to seasonal in nature for locals, as well as creates opportunities for new markets for the local products. Here community participation supports local economic development through diversification of employment. On the other hand, poor payment

is made to locals by the tourism business operators. There are very Poor shopping facilities for tourists. The results of the study demonstrate that at a local level there is a strong support for tourism development, particularly due to its lucrative economic advantage. Similarly, the partial regression coefficient for socio-cultural impacts (I2) is -.224 with value of beta coefficient is -.204 and value of t statistics is -4.468 which is significant also at  $\alpha = 0.05$ .

In this factor, the local residents are not perceived the development of tourism as a factor that provides cultural distinctiveness. Interaction between tourists and hosts are perceived as negative because local people of Saint Martin Island are very conservative mentality and as the Island is only bounded by 8 k.m. so the local don't want any change of local traditional life style of them. Moreover they thought social problems (crime, gambling, unauthorized drug selling) can be increased among community people that will diminish authenticity of locals lifestyles. The partial regression coefficient for environmental impacts (I3) is -.506 with value of beta coefficient is -.460 and value of t statistics is 8.521 which is significant also at  $\alpha = 0.05$ . Finally, in case of last factor, The partial regression coefficient for physical impacts (I4) is -.239 with value of beta coefficient is -.217 and value of t statistics is -4.762 which is significant also at  $\alpha = 0.05$ . Tourism has both positive and negative impacts on environment. The effects of tourism development on the natural environment of Saint Martin Island and its landscape are not perceived as being positive.



The community felt that tourism is damaging natural environment and landscape gradually specially at peak season from October to March. They also thought that pollution is increasing due to tourist unconsciousness. They dropped different packets, water bottle, can, banana, breads packets etc. that will degrade the environmental sustainability. Construction of excessive tourists facilities (hotels, resorts, restaurants, generator supply for current and water availability) also threaten for sea animals. The number of endangered sea turtles, including the green turtle and Olive Ridley turtle, that visit the island every winter to lay eggs has decreased significantly in recent years. Some residents stated, "If we can earn money, it doesn't matter that our environment is damaged a little". So proper preservation and conservation should be taken to save the beautiful Saint martin Island. In case of physical impacts (I4), we can see that unauthorized and improper buildings

and hotels/ resorts are built without proper plan which is not feasible for Saint martin Island because excessive constructions ( resorts, hotels, restaurants, water transportations) damage environmental sustainability as well as make disturbance to local residents lifestyles. The results show that local residents see tourism as an income generator, but at the same time they understand the importance of environmental sustainability of Saint Martin Island. Finally, this study has several limitations: primarily, limited time and very poor budget. This study did not clarify properly how the residents perceive themselves as benefiting from tourism development.

### 7.3 Descriptive Statistics and Frequency Table

Among 150 local residents of Sajek valley, 106 were male and 44 were female that is shown in table-7 and figure-3.

		Frequency	Percent	Valid Percent	Cumulative Percent
Valid	Male	106	34.6	70.7	70.7
	Female	44	14.4	29.3	100.0
	Total	150	49.0	100.0	
Missing	System	156	51.0		
Total		306	100.0		

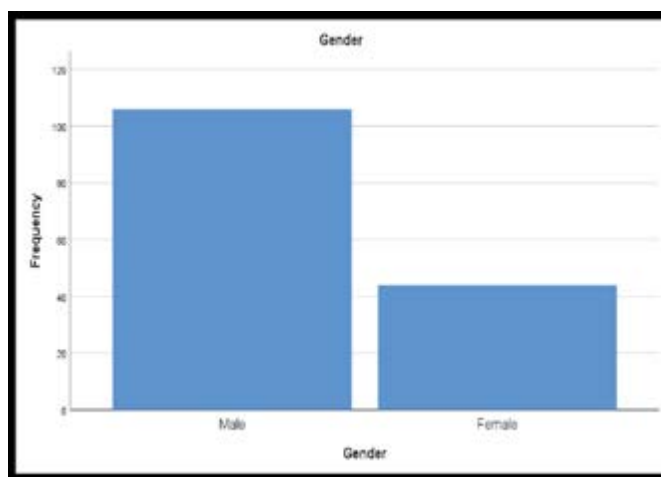

**Fig. 3. Bar Chart**

## 8. FINDINGS

The results of the study indicated that local residents had favorable attitudes toward tourism development in terms of its positive economic impact only.

Multiple regression analysis indicated that local residents' perceived overall happiness was significantly influenced by both positive and negative cultural and environmental impact and positive economic impact factors. The local residents also agreed that the development of tourism in their region provides more recreational opportunities and interaction with the tourists can be positive if local residents are provided training to welcome tourists as well as community participation can be a vital mechanisms to make good positive relations between local residents and tourists.

Multiple regression analysis also indicated that there are no significant results in case of physical impacts. Therefore physical impacts (I4) should be kept for further research because this is not applicable for our research as well as very less significant in case of influencing local residents attitude towards tourism development. They felt tourism has a negative influence on local services offered, including items such as improvements of roads and public services because the more the constructions ( resorts, hotels, restaurants, water transportations) has built for the tourists , the more the degradation will be occurred for the environment that damage sustainability of local residents.

## 9. RECOMMENDATIONS

Government should take several initiatives by organizing several types of training program for both local male and female workers to create entrepreneurs and also awareness development program should be introduced among them.

Strengthen infrastructure and capacity for resource management, primarily targeting marine protected areas.

Conservation of special habitats and eco-systems such as hill forests, wetlands, mangrove ecosystems, coral reef ecosystems as well as the protection of migratory animals and birds; Each person visiting the island brings in additional issues to be taken care of like drinking water, sewage, solid waste, food,

accommodation, etc.

Develop and implement environmental, biological, socioeconomic and user monitoring programmes.

Cooperation with the various law enforcement and paramilitary agencies like the Bangladesh Police, Bangladesh Rifles, and Bangladesh Coast Guards should be further strengthened to protect the island's biodiversity and tourist management

“Tourism Carrying Capacity” and Visitor Management Program” (VMP) tools should be known by the local residents to ensure preservation of natural resources for both current and future generations.

## 10. CONCLUSIONS

The local residents perceived greater level of economic gain and hence perceived the impact of tourism development to be positive. They especially felt that tourism has positive effects on the local economy, such as improving the economy, creating job opportunities (part time, full time), improving standards of living, reducing poverty and hunger level and they also agreed that tourism can result in a number of quality-of-life improvements. It was possible to earn a substantial revenue through tourism without disturbing the ecological balance. It proposed formulating special guidelines for governance that would set fixed accommodation such as hotels and resorts and tourist numbers by using Visitor management program (VMP). Water transports should also be used in a limited number by following the guidelines of carrying capacity techniques and Limits of Acceptable Change (LAC) tools should acknowledge among the local residents to create awareness of sustainable tourism. The government should carry out a thorough scientific study to determine the island's current state of environmental degradation and should take cues from Thailand and Indonesia and go for ecotourism to conserve St Martin's biodiversity. Approximately BDT15.85 crore (BDT158.5 million ~ USD1.95 million) project has undertaken recently to conserve and improve the island's biodiversity, including by recreating Keya tree (screw-pine; Pandanus odorifer) forests, regenerate and conserve coral, and create alternative jobs for coral and shell collectors. But recognizing the seriousness of ecological

problems, the community has become increasingly environmentally conscious. It could be that the local residents are conscious of the possible drawbacks of hotel and resorts constructions at the detriment of environmental sustainability.

## References

- [1] Akis, S., Peristianis, N. & Warner, J. (1996). Residents attitudes to tourism development: the case of Cyprus. *Tourism Management*, 17(7), 481-404.
- [2] Allen, L. R., Long, P. T., Perdue, R. R. & Kieselbach, S. (1988). The impact of tourism development on residents' perception of community life. *Journal of Travel Research*, 27(1), 16-21.
- [3] Allen, L. R., Hafer, H. R., Long, P. T. & Perdue, R. R. (1993). Rural residents attitudes toward recreation and tourism development. *Journal of Travel Research*, 31(4), 27-33.
- [4] Allport, G. W. (1935). Attitudes. In C. Murchison (Ed.), *A handbook of Social Psychology* (pp. 798-844).
- [5] Bramwell, B. (1996) Sustainable Tourism Management Education in Europe. *Tourism Management*, 17(4), pp. 307-310.
- [6] Coccossis, H. (1996) Tourism and Sustainability: Perspectives and Implications. In: Prietley, G. K., Edwardas, J. A. and Coccossis, H. eds. *Sustainable Tourism? European Experiences*. CABI, UK, pp. 1-21.
- [7] Crompton, J. L. (1979). Motivations for pleasure vacation. *Ann. Tour. Res.* 1979, 6, pp. 408-424.
- [8] Dann, G. M. S. (1997). Anomie, ego-enhancement and tourism. *Ann. Tour. Res.* 1977, 4, pp. 184-194.
- [9] Feeroz, M. M. (2009). Effects of Environmental Degradation on Food Security in the St. Martin's Island of Bangladesh. A Study carried out with the support of the National Food Policy Capacity Strengthening Programme, pp. 12
- [10] Gee, C. Y., Mackens, J. C. & Choy, D. J. (1989). *The Travel Industry*. New York: Van Nostrand Reinhold.
- [11] Giannakis, E. The role of rural tourism on the development of rural areas: The case of Cyprus Elias. *Romanian J. Reg. Sci.* 2014, 8, 38-53.
- [12] Garau, C. Perspectives on cultural and sustainable rural tourism in a smart region: The case study of Marmilla in Sardinia (Italy). *Sustainability* 2015, 7, 6412-6434. [CrossRef]
- [13] Haque. M. (2000) 'Implementation of International Conventions, Treaties and Protocols on Environment and Development', Bangladesh State of Environment Report (Dhaka: FEJB) pp. 285-293.
- [14] Hasan. J. (2000) 'Environmental Laws in Bangladesh: In Search of a Regulatory Framework', Bangladesh State of Environment Report (Dhaka: FEJB) pp. 297-306.
- [15] Islam. M. Z. (2002a) 'Marine Turtle Nesting at St. Martin's Island', *Marine Turtles Newsletter* 96, pp. 19-21
- [16] Islam. M. Z. (2002b) 'Threats to Sea Turtles in St. Martins Island, Bangladesh', *Kachhapa* 6, pp 8-11.
- [17] Islam. M. Z. (2001) St. Martin Pilot Project, National Conservation Strategy (NCS) Implementation Project-1, Final Report (Dhaka: Ministry of Environment & Forest, Government of the Peoples Republic of Bangladesh).
- [18] Mollah. A. R. (1997) 'Status of Coral and Associated Resources in Bangladesh', FAO Corporate Document Repository, [www.fao.org/docrep/x5627e/x5627e08.htm](http://www.fao.org/docrep/x5627e/x5627e08.htm) 23 March 2009.
- [19] RajaSuriya, A., Zahir, H., Muley, E. V., Subrimunian, B. R., Venkataraman, W., Khan, M. H. and Whitingham. E. (2000) 'Status of Coral Reefs in South Asia: Bangladesh, India, Maldives and Sri Lanka', *Status of the Coral Reef of the World Newsletter* 6, pp. 95-116.
- [20] Rashid. S. M. A. (2008) 'Is Restriction on Construction Enough to Protect St. Martins Biodiversity?' *The Daily Star*, 5 May 2008.
- [21] Rashid. S. M. A. (1997) 'Bangladesh National Report for the Northern Indian Ocean Sea Turtle Workshop and Strategic Planning' (Incomplete citation).
- [22] Ramseook-Munhurrun, P.; Naidoo, P. Residents' attitudes toward perceived tourism benefits. *Int. J. Manag. Mark. Res.* 2011, 4, 45-56.
- [23] Shariff, N.M.; Abidin, A.Z. Community attitude towards tourism impacts: Developing a standard instrument in the Malaysian context. *E-J. Soc. Sci. Res.* 2013, 1, 386-396.
- [24] Singh, R.B. and Mishra, D.K. 2004. Green tourism in mountain regions: Reducing vulnerability and promoting people and place centric development in the Himalayas. *Journal of Mountain Science*, 1 (1), 57 -64.
- [25] Singh, R. B., Mal, S., and Kala, C. P. 2009. Community responses to mountain tourism: A case in Bhyundar valley, Indian Himalaya. *Journal of Mountain Science*, 6 (4), 394 -404.
- [26] Sirakaya, E. Teye, V., and Sönmez, S. F. 2002. Understanding residents' support for tourism development in the Central Region of Ghana. *Journal of Travel Research*, 41, 57 -67.
- [27] Stetic, S. Specific features of rural tourism destinations management. *J. Settl. Spat. Plan.* 2012, 1, 131-137.
- [28] Trousdale, W., 1999, "Governance in Context: Boracay Island, Philippines" *Annals of Tourism Research*, pp. 840-867.
- [29] Vargas -Sánchez, A., Porras -Bueno, N. and Plaza -Mejía, M. 2011. Explaining residents' attitudes to tourism: Is a universal model possible?. *Annals of tourism research*, 38 (2), 460 -480.
- [30] Wang, Y. and Pfister, R.E. 2008. Resident's attitudes toward tourism and perceived personal benefits in a rural community. *Journal of Travel Research*, 47 (1), 84-93.

# APPLICATION OF SPACE SYNTAX ANALYSIS IN LALBAGH

## *Exploring The Links Between Spatial Analysis And Drug Crime Pattern In Selected Streets Of Lalbagh, Dhaka*

**Sabbir Ahmed**

Lecturer, Department of Architecture, Military Institute of Science and Technology  
Mirpur Cantonment, Dhaka-1216, Bangladesh  
E-mail: sabbirahmed@arch.mist.ac.bd

### ABSTRACT

Drug crime is an urban problem, and in Lalbagh, its occurrence is fairly common. It can nevertheless be prevented with surveillance, a feature of urban design. Spatial studies and criminology enable us to know significantly about where and why crime occurs. Criminals are rational individuals and they weigh risks and opportunities. A direct correlation can thus be found between the following variables: 1. Risk & Opportunity and 2. Physical Implications of Urban Design which includes spatial attributes. The aim of this paper is to identify the spatial attributes of a major drug crime location (Lalbagh) for helping urban planners, designers and crime control authorities to identify crime zones easily for acting “proactively” rather than “reactively” to the crime. While designing or examining neighbourhoods, for high values of Integration, Integration  $R=3$  and Integration  $R=10$  and Connectivity of an area, we can predict that area to be less crime-prone; because with higher levels of movement, levels of co-presence and co-awareness are expected to be higher. Based on this principle, selected streets of Lalbagh have been studied. Out of the other smaller streets of Lalbagh, Road 10, Shahidnagar was found to be particularly prone to criminal activities and this paper is focused on finding out the reasons behind it, on the basis of space syntax analysis. Depthmap software has been used as a tool to analyze and explain this pattern of drug crime.

**Key words:** Urban Morphology, Space Syntax, Criminology, Drug Crime, Old Dhaka, Urban Design.

### 1.0 INTRODUCTION

Crime is a predominant urban problem blamed for the decline of “quality of life” in urban settings. The focus is now shifting from deterrence to prevention of crime. Since criminals are rational individuals, they weigh risks and opportunities; hence Fanek and Jones (1997) assume a direct correlation between the following two variables: 1. Risk & Opportunity and 2. Physical Implications of Urban Design. [1] According to “Criminometric Models” in Quantitative Criminology, criminals act rationally and they weigh expected costs vs expected gains. Expected costs of crime include the following: 1. Opportunity costs and 2. Expected time in prison (if arrested). Crime prevention is, therefore, possible through designing physical attributes of the environment. Organising neighbourhood watches is a plausible approach, according to Charles Moore,

while other theories such as Oscar Newman’s “Defensible Space” and Jean Jacobs’ “Eyes on the Street” also recognise the importance of surveillance as an effective measure of crime prevention.

Applications of theory and research based on Space Syntax can enhance a range of environments. Designed circulation patterns can improve levels of social interaction and “surveillance”. As mentioned earlier, raised social physical interaction will discourage criminals (rational individuals who calculate risk and gain) to commit crime.

Crime like drug dealing in public places such as the streets of Lalbagh is a widespread phenomenon. According to Mamun and Nilufar (2015), street accessibility, proximity to specific land use, the number of intersections that need to be crossed to reach a street at a local level has a significant effect

on the locational choice of drug dealing. Rational choices (to movement) of streets and mixed-use residential areas with close proximity to poorly integrated streets show more vulnerability for becoming drug-selling point. Also, the streets having drug crime record show an inverse relation between streets control value and weighted choice value at local level. [2] While it is clear that spatial attributes are important to study in order to predict the possibility of crime occurrence, this paper focuses on investigating the spatial attributes of crime-prone streets in Lalbagh.

## 2.0 CRIME PATTERN AND SPACE

In the words of Charles Murray, *Common sense and everyday experience tell us that the physical environment is related to the risk of crime. That's why most people avoid poorly lighted streets and run-down neighbourhoods, thinking that they are more vulnerable targets in such places. This calculation about the specific chance of becoming a victim goes hand in hand with another common sense of understanding about crime: one of our best protections against crime is to live in a community where neighbours watch out for each other and stand ready to call the police or to intervene directly when they spot a malefactor.* [3]

While the above statement solidifies the relationship between spatial attributes and frequency of crime occurrence, other sources attempt to confirm and specify these spatial attributes: following are the key points extracted from P.L. Brantingham and P.J. Brantingham's paper on Crime Pattern Theory (2008). [4] [5]

- Criminals go through a sequence of daily activity and cross some routes on a regular basis and take decision whether to commit a crime.
- Usually, criminals do not function individually; they always try to be at groups of friends or family.
- Criminals commit crime finding triggering event within their daily routes.
- There is a limited range for every individual's daily activity, these comprise of workplace, markets, schools, mosques, hospitals and nodes between them.
- Criminals have a similar kind of spatial movement like a law-abiding person.
- Possible targets or victims usually have passive or

active activity space that shares the boundary of the offender and the occurrence of a crime depends on the will of the offender.

- Within the built urban form, crime generators are created by high flows of people through and to nodal activity points.

## 3.0 LITERATURE REVIEW

As discussed earlier, research has been conducted relating crime to spatial attributes of urban space in various places of the world. A research gap remains as to whether these spatial principles also apply to the unique scenario of Old Dhaka, particularly the labyrinthine street patterns of Old Dhaka. Lalbagh, home to the historic fort "Lalbagh Kella", is a significant part of Old Dhaka, rich with history, culture and heritage. Tabassum (2008) argues that spatial patterns suggest phase developments in both old and new domains of Dhaka, among which two distinct phases are clearly observed, Old Dhaka and New Dhaka, existing side by side. [6] According to Siddiqui et al (1991), Old Dhaka is the 'indigenous' historic core and New Dhaka is the 'informally' developed, extemporaneous settlement of recent years. [8] Nilufar (2004) adds that the historical core of Old Dhaka retains the traditional features of the urban settlement that it has inherited from the past and the natural endowment of its organic morphology is valued for its 'indigenous' urban pattern. [7] Thus, it can be an interesting research outcome if the street patterns of Old Dhaka can be studied with reference to human behaviour. Space syntax is a useful method to study the behavioural patterns of urban space in terms of "syntactic properties" such as integration, choice etc. [9]

In this paper, the crime of selling illegal drugs has been referred to as "drug crime". Drug crime has been chosen for analysis in this paper for the following reasons:

- Drug crime data is easily available.
- Drug crime is the most prominent crime in the selected area and it occurs in good numbers, and as such, the pattern for its locational choice has been identifiable.
- Streets are the major channels of movement and the most prominent public spaces. Since the task is to explore which street is the most vulnerable and why, drug crime has been chosen because it is the only crime occurring only on streets.

### 4.0 AIM AND OBJECTIVES

The aim of this paper is to identify the spatial attributes of a major drug crime location for helping urban planners, designers and crime control authorities to identify crime zones easily so that they can act proactively rather than reactively to the crime. The main objectives are:

- To identify drug crime pattern in the streets of Lalbagh area that are under a single police station, from the data received from the police station.
- To identify the spatial attributes of the most prominent drug crime spots using space syntax.
- To analyze and compare these spatial attributes obtained from the simulation in the form of various syntactic properties and interpret the scenario on the basis of these values.

### 5.0 METHODOLOGY

The methodology of this research can be termed as a case study, in order to examine the state of a presumed correlation, particularly the correlation between spatial configuration and the frequency of crime occurrence, in the specific case of Lalbagh, Dhaka. The method for establishing this correlation is Space Syntax, and for analysis, free software DepthMap has been used as a tool. Spatial layouts of urban spaces powerfully influence human behaviours such as the behaviour of criminals, which can be thoroughly analyzed by the science-based and human-focused approach called Space Syntax. [10] Jones and Fanek (1997) mentions with evidence that, while designing or examining neighbourhoods, for high values of Integration, Integration R=3 and Integration R=10 and Connectivity of an area, we can predict that area to be less crime-prone; since with higher levels of movement, levels of co-presence and co-awareness are expected to be higher. [1] Based on this principle, the data from DepthMap has been analysed to relate and compare crime data to “syntactic properties” of drug-crime-prone streets in Lalbagh, to check to what degree space syntax rules apply in this case.

### 6.0 DATA FROM SURVEY AND SIMULATION

The drug crime data for January 2017 found in Lalbagh Police Station is numerically presented below in descending order with street names:

**Table 1.** Summary of Drug Crime Data, Lalbagh.

Arterial Roads		Street Branches	
Street Name	Drug Crime Occurrence	Street Name	Drug Crime Occurrence
Lalbagh Road	2	10, Shahidnagar	7
RND Road	2	4, Shahidnagar	2
Nababganj Road	2	1, Shahidnagar	2
New Paltan Line	2	2, Shahidnagar	1
Gangaram Bazar Lane	2	5, Shahidnagar	1
Azimpur Road	1	8, Shahidnagar	1
Beribadh Road	1	Haque Bakery	1
		Nababganj Park Road	1
		Nababganj Bazar Road	1
		13, Nababganj	1
		Sheikh Shaheb Bazar	1
		Koshai Road	1
		Ferdous Jame Mosque	1
		JN Saha Lane	1
		Lalbagh 3 BGB	1

**Source:** Lalbagh Thana Police Station.

It is important to mention here that the Arterial Roads are greater in length and are used as the main vehicular routes, and therefore cover more areas for drug crime to take place. Nonetheless, the statistics exhibit that these Arterial Roads are prone to far less crime occurrence with respect to their length superiority. Out of the other smaller streets, *Road 10, Shahidnagar* is evidently very prone to criminal activities and this paper is focused on finding out why, on the basis of space syntax analysis.



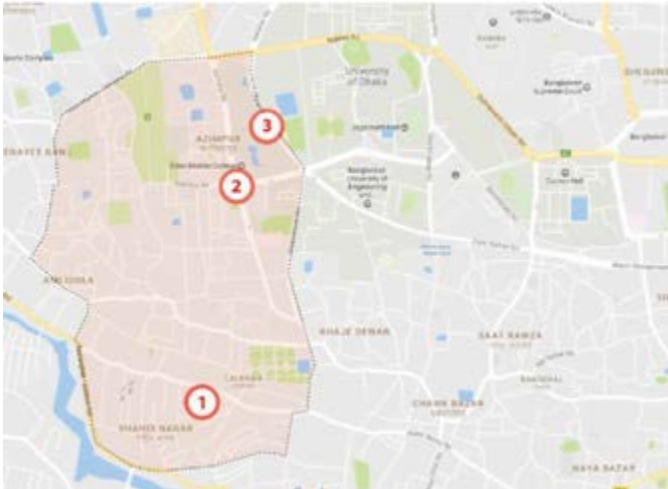

**Fig 1.** Area under Lalbagh Police Station. 1. Location of Road 10, Shahidnagar, 2 & 3. Police Checkpoints.



**Fig 3.** Road 10, Shahidnagar in the map.

Using Depth Map software, axial maps and syntactic values are generated for Lalbagh area with surroundings and analyzed and compared with the crime data.



**Fig 2.** Part of Dhaka city’s axial map used for analysis, Left and right circles denoting respectively the least and most integrated areas of Lalbagh



**Fig 4A.** Axial map and location of Road 10, *Shahidnagar*





**Fig 4B.** Brown Circle shows the location of the nearest Integration Core

Figure 4B shows that the nearest integration core is away from the study area denoted by the pink circle at the left. The study area, inside the pink circle, also appear to be consisting of the bluest (least integrated) lines, axial representation of *Shahidnagar* lanes. This locational choice for the selling of drugs can be easily explained from the crime data. Almost 43 percent of the alleged drug crime had been occurring in these lanes alone.



**Fig 4C.** Axial map with Integration R=n lines

Figure 4C shows that Road 10, *Shahidnagar* is more integrated than most of the roads to the left only. Figure 4D shows that this road comprises one of the least integrated lines (with the exception

of dead ends). Since Integration R=10 signifies vehicular movement[1], Road 10, *Shahidnagar* can be predicted to oversee one of the lowest amounts of vehicular movements. In fact, field observation indicates this road can barely provide space for two rickshaws crossing each other. Whereas vehicular movement is a limiting factor for crime occurrence, lack of vehicular movement, in this case, seems to be a driving factor of drug crime in streets.



**Fig 4D.** Axial map with Integration R=10 lines



**Fig 4E.** Axial map with Integration R=4 lines

Figure 4D and 4E show that despite not being peripheral roads or dead ends, *Shahidnagar* lanes are clearly the least integrated within the system. Since Integration R=4 and Integration R=3 signify pedestrian movement, most *Shahidnagar* lanes,

including Road 10, *Shahidnagar* characterize the lowest pedestrian movements. A lack of pedestrian movement results in decreased surveillance and hence an increase in the crime rates.

## 7.0 ANALYSIS AND INTERPRETATION

A brief statistical analysis of syntactic properties within the entire system is presented below:

Measure	Integration [HH] R3	Control	Choice R3
Average	1.88	1	66.55
Minimum	0.33	0.14	0
Maximum	3.88	3.46	3088
Standard Deviation	0.64	0.44	166.15
Avg. – Std. Dev.	1.24	0.56	< 0
Avg. value for RND Road’s least integrated part	1.31	1.33	14.3
Avg. Value for Road 10, Shahidnagar	1.56	0.98	19.5



**Fig 4F.** Axial map with Integration R=3 lines

Figure 4F illustrates a zoomed part of the axial map with Integration R=3 lines, which shows Road 10, *Shahidnagar* appearing to have been originated from the least integrated part of its nearest arterial road or mother road, *RND Road*. This implies that *RND Road*, being a principal route of movement for the neighbourhood, supports “high flows of people” needed to generate drug crime according to crime pattern theory, and drug selling is performed in Road 10, *Shahidnagar*, an area with “low movement” rates of pedestrians.

Other notable attributes include that the area has lower than the average Connectivity value (3 against the average 5), close to the maximum Entropy R3 value (1.5 against a maximum 1.56) and slightly lower than average Mean Depth R3 value (2.25 against 2.4). Interpretation of these attributes are listed below:



**Fig 5.** Axial map of *Shahidnagar* area

- The Integration [HH] R3 values of the drug crime-prone area of streets are close to “(Average) – (Std. Dev.)” value of the axial map, which means the area is significantly low on pedestrian movement. Field observations indicate that the roads are also narrow and poorly lit after sunsets, while the buildings have minimum visual and physical interaction with the street.

- The Control values of the drug-crime-prone area of streets are close to 1, signifying their strength as a control space. Control is a dynamic local measure of the degree to which a space controls access to its immediate neighbours taking into account the number of alternative connections that each of these neighbours has. People rarely cross Road 10, *Shahidnagar* when they need to go to other places.

- The Choice R3 values of the drug crime prone area of streets are close to 0, the minimum value, highlighting the fact that there is minimum “flow” through them. Choice R3 measures how likely an axial line or a street segment it is to be passed through on all shortest routes from all spaces to all other spaces within a radius of 3 from each segment.

- Entropy in DepthMap is a measure of the distribution

of locations of spaces in terms of their depth from a space rather than the depth itself. If many locations are close to a space, the depth from that space is asymmetric, and the entropy is low. If the depth is more evenly distributed, the entropy is higher. The latter is clearly the case of Road 10, Shahidnagar, which can be interpreted as few locations being close to it, and as a result, an increased crime occurrence.

## 8.0 RESULTS AND DISCUSSION

To summarize, Road 10, Shahidnagar, particularly prone to drug crime among the smaller streets of Lalbagh, was found **to be far from the integration core, to have among the lowest Integration R=10 and Integration R=3 values, near to average Control value, much below average Choice R3 value and a very high Entropy value** as syntactic properties of space. Thus, for the selected streets of Lalbagh, the results showing minimal frequency of people's movement are not in consistence with Crime Pattern Theory; nevertheless, the results can be well interpreted as a lack of "surveillance" being the main cause of crime occurrence – this behavioural feature made easy to be analysed by means of Space Syntax.

This analysis generates encouraging results to prove that syntactic measures of spatial analysis can explain drug crime rates of streets, particularly in the case of Lalbagh area, although crime data of a much longer period could have generated better results. The physical condition of the street can also be attributed as an important factor of crime occurrence in Lalbagh. Further photographic and map data would have been more helpful but could not be taken as a helping hand due to time constraints, whereas crime data from a much longer time period would have been more useful. Nevertheless, these findings could pave the way for further research having the application of Space Syntax methodology in Old Dhaka.

## 9.0 CONCLUSION

This paper has attempted to understand the relation of human behaviour as in the behaviour of criminals at Lalbagh with respect to spatial features of built-up urban areas with the help of Space Syntax. The results mark the absence of surveillance in the street as the main cause of crime occurrence; however, further research involving extensive crime data will

help us accurately predict the spatial features of drug-crime-prone streets at Lalbagh, Old Dhaka.

In the design of environments, the police can be more vigorously involved with architects and planners utilizing Space Syntax methodology to make it less crime-prone in Dhaka City. It is encouraged to take into account the physical condition of the street and the adjacent land use along with spatial analysis, nevertheless, Space Syntax methodology has turned out to be a fairly efficient tool for explaining drug crime in Lalbagh, while it can be expected to generate similar results for the other parts of the city. Besides drug crime, other aspects of human behaviour can be studied and related to space syntax in future research proposals.

## Acknowledgements

Heartfelt gratitude to Dr Farida Nilufar for her caring supervision and useful guidance; and Mustafizur Rahaman Arman for his inspiration.

## References

- [1] A Jones, M & F Fanek, M. Crime in the Urban Environment. Symposium, UCL, London, UK; 1997.
- [2] Mamun, SB & Nilufar, F. Drug Crime and Urban Activity Pattern: The Locational Choice of Drug Crime in Relation to Street Type and Land Use. Proceedings of the 8th International Conference of Faculty of Architecture Research Unit (FARU), University of Moratuwa, Sri Lanka, pp. 000–000; 2015.
- [3] Murray, C. "The Physical Environment," Crime. San Francisco: Institute of Contemporary Studies; 1995.
- [4] Brantingham, PL & Brantingham PJ. Crime Pattern Theory, "Environment Criminology and Crime Analysis" Editor: Richard Wortley and Lorraine Mazerolle, Cullompton, UK: Willan; 2008.
- [5] Brantingham, PL & Brantingham PJ. "Environment, Routine and Situation: toward a pattern theory of crime"; 1993.
- [6] Tabassum, T. Analyzing a Traditional Neighbourhood Pattern of Old Dhaka: A Case of Tantibazaar; 2016.
- [7] Nilufer, F. Hidden Morphological Order in an Organic City Journal of Protibesh. 10. 33-40; 2004.
- [8] Siddique, K et. al., Social Formation in Dhaka city - A study in the third world urban society, Dhaka University press limited; 1991.
- [9] Hillier, B & Hanson J. The Social Logic of Space". Cambridge University Press, Cambridge; 1984.
- [10] Space Syntax, Available at: <https://spacesyntax.com/about-us/>, Accessed on 2 February 2019.

# ORGANIZATION AND MANAGEMENT PRACTICES OF UNIVERSITY LIBRARIES IN BANGLADESH: AN EVALUATION

Lieutenant Colonel Muhammad Sanullah<sup>(1)</sup> and Md. Moslem Uddin<sup>(2)</sup>

1. General Staff Officer-Grade-1 (Research), Military Institute of Science and Technology  
Mirpur Cantonment, Dhaka-1216, Bangladesh  
E-mail: gso1@mist.ac.bd, mssanaul35@gmail.com
2. Librarian, Military Institute of Science and Technology  
Mirpur Cantonment, Dhaka-1216, Bangladesh  
E-mail: librarian@mist.ac.bd, moslemuddin75@yahoo.com

## ABSTRACT

This article provides an overview of the university libraries and explains in detail their various organizations, management, collections, functions, systems, and services as a whole. It also profiles careers in library work, the education of librarians, and several professional organizations for librarians. Academic libraries function almost as the hearts in the academic activities of the University. The libraries perform their functions properly, a body of knowledge has been developed and incorporated within the scope of the training programs in library management. That's why a qualified librarian is needed to meet up such requirements. It is quite impossible to control the entire library in pen and paper where there are a huge amount of books for the librarian. A librarian (he/she) has to serve not only a single job, but also multiple jobs simultaneously. That's why it is difficult to keep track of those jobs. Library management is the theoretical concepts of managing such a library efficiently. Finally, the article describes contemporary library management in various university libraries in Bangladesh.

**Key words:** Librarianship, Library Program, Library Administration, Automation, Library System, Research Organization, Library Management, Library Function, Library Service, Survey.

## 1.0 INTRODUCTION

The library is a key to the knowledge of the world. The importance of the library in higher education a university must have a well-equipped and functional library so that it becomes an intellectual hub of the institution both for students and teachers.

An academic library is a library that is attached to a higher education institution and serves two complementary purposes; to support the curriculum and to support the research of the university faculty and students (en.wikipedia.org).

An academic library is a library associated with a college or university which supports the mission of the institution and the research needs of its faculty, staff, and students. (igi-global.com).

A library is the storehouse of knowledge. The mission of a library is to collect, organize management, preserve and provide access to knowledge and information. In fulfilling this mission, libraries preserve a valuable record of a culture that can be passed down to succeeding generations. Libraries are an essential link in this communication between the past, present and future. Whether the culture record is contained in books or electronic formats, libraries ensure that the record is preserved and made available for later use. Libraries provide people with access to the information they need to work, play, learn and govern. Libraries are now recognized as important social institutions. The library is one of the most important parts of social life at any time. It satisfies our thirst for the unseen and the unknown. No educational institute is complete without a library.



The conventional function of academic libraries is to collect, process, disseminate, store and utilize information to provide service to the university community. However, the environment in which academic libraries operate today is changing. Academic libraries are part of the university and its organizational culture. As a result, the role of academic libraries is changing to provide a competitive advantage for the parent universities. The success of academic libraries depends on their ability to utilize information and knowledge of its staff to better serve the needs of the academic community. This requires academic librarians to reappraise their functions, expand their roles and responsibilities to effectively contribute and meet the needs of a diverse university community. Knowledge management is a viable means in which academic libraries could improve their services in the present knowledge era.

## 2.0 OBJECTIVES OF THE STUDY

The university library has its own aims and objectives to render smooth services to its clients and to fulfill these, the library requires necessary staff, satisfactory collection, own building, sufficient budget, etc. Information technology has brought drastic and dramatic changes in the functioning of the libraries and render services. This study highlights the concept of librarianship, challenges of the profession, function of the library, administration, book collection, staff, and finance, physical plan the status of organization and management practice university libraries of Bangladesh. The objectives of the article are as follows:

- a. To exploit the concept of the librarianship;
- b. To study the challenges of the library profession;
- c. To know the function of the library;
- d. To know the library administration and use of library resources effectively;
- e. To identify the problems faced by the readers as well as by the library professionals;
- f. To know computer use in library management;
- g. To adhere to international standards in terms of library management.

## 3.0 LIBRARIANSHIP

Presently there is a radical change in the library profession. A university library has to be organized and administered on a scientific basis and by the

latest trends in library science. The profession of librarianship in our country is of recent growth and has yet to become a “discipline” at par with the professions of medicine and law. The administrator perhaps does not still know that Dr. S. R. Ranganathan, the father of library science in India has involved the following laws those are now applied to the technical processes of purchasing and preserving the books:

- a. Books are for use;
- b. Every reader has book;
- c. Every book its reader;
- d. Save the time of the reader; and
- e. Library is a growing organism.

Librarianship is a combination of both an art and a science and the job of the librarian is no longer electrical or mechanical in nature. It is technical in relation to the organization of the library on scientific lines and is intellectual in relation to the “Reference Service” to a reader and the teaching staff. The administrative duties involve scientific principles of management of the library. The reader and the service to him/her through reading materials in the library is the fundamental objective of library administration.

## 4.0 LIBRARIANSHIP IS A CHALLENGING PROFESSION

Librarianship is a challenging profession and use of books is the real test of a librarian’s overall success. To increase the usefulness of the books the university librarian has to play the following four rules:

- 4.1 *As a collector*, he should constantly reinforce the existing collection by seeking out and acquiring materials which expand their usefulness.
- 4.2 *As a bibliographer*, he should devise the scheme of cataloguing and classification to make books more useful to his clients.
- 4.3 *As a teacher*, he should provide reference services and group instructions, enabling readers to exhibit more effectively.
- 4.4 *As an administrator*, he should adopt many measures to increase the accessibility of books and thus enhance their usefulness.

To achieve all these aims, the librarian must have a specialized library personnel who should assist him in providing a smoothly integrated service. It is impossible in the 21st century for these functions

by himself in view of the growing size of the library. The variety of undertakings, and the professional and administrative duties entrusted to him through are growing needs in a prosperous library.

## 5.0 LIBRARY PROGRAM

The library is one of the units of a university, of which it is a part indeed. The library program is mainly concerned with the teaching of the students who use the library to meet the institutional need and to improve their assignment of works. It is felt that the libraries have not been effectively organized and much thought has not been given to the following matters which are essential for making the library a great educational force on the university campus.

- a. Planning, organization, and equipment;
- b. Book selection and acquisition of periodicals;
- c. Librarian and the library staff;
- d. Library service;
- e. Library hours;
- f. Issue system;
- g. Stock verification;
- h. Bibliographical work;

In some of the technical institute and university, the administrators are no doubt taking a good deal of interest in developing the library program, but lack of funds, library staff, and support of faculty members are some of the bottle-necks which hinder their progress. Most of the universities also do not process highly-trained librarians who understand the problems of teachers and students in the use of library books and bibliography and assist the faculty members in carrying out the objectives of the university [20].

## 6.0 FUNCTIONAL MANAGEMENT OF THE LIBRARY

“Library is a growing organism”, so says the fifth law of Library Science. With its steady and rapid growth, it becomes necessary that a library should be well organized and managed. This work calls for the study of principles of administration as applied in a big business area.

The general theory of administration is equally applicable to the field of library science. The latest techniques of management have been involved and

employed for the full utilization of human and material resources. For rationalization of work and simplification of routine work to avoid delay and red taped in the top management.

Materials and processes have been standardized to facilitate the flow of work on most smooth and economical patterns. In the modern age of machinery, it has become obligatory to streamline the administration and to unify all the details, involved in library administration.

By formulating the five fundamental laws of Library Science Ranganathan has helped in the elucidation and classifying “the thought both in the General Theory of Administration and in its application to the field of Library Science”, and his monumental work, “Library Administration” lays down the details of the daily administration of libraries. These provide a handy manual for planning the work of library staff in each section of the library. It also helps in functional basis and for scientific management of the library.

## 7.0 LIBRARY SYSTEMS

‘Systems’ means a totality of many a system inter-related to achieve some goals or render a service an analysis of which would detect, locate and identify problems confronting an organization. Systems analysis is no solution to problems, but it does suggest alternative solutions to problems. It is designed to help the management to bring structural changes in the organization to adjust to changes in the environment.

Since here we are not concerned with the analysis of library systems-since we refer to systems analysis only to point out how innovation can be inducted into library administration-we shall present a simple total library system and then see how we may identify the problems in the library organization by charting the workflows that make processes and systems in the library organization.

The following systems make a simple total library system:

- A = Acquisitions System
- P = Processing System
- C = Circulation System

Each system in the total library system can be analyzed in terms of the following flow process charts:

**1) Acquisitions Process: S→O→R→A = SORA= Acquisitions System**

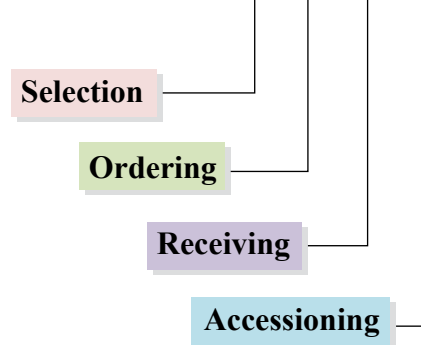

**Fig 1. Acquisitions Process**

**2) Processing Process: C→C→PC→L = CCPCL= Processing System**

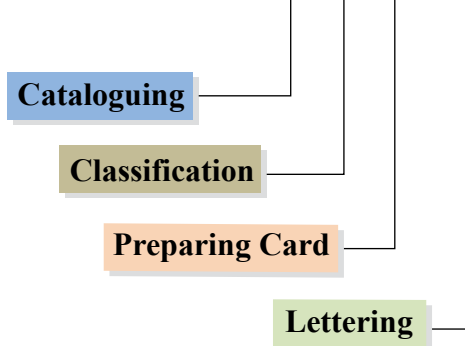

**Fig. 2. Processing Process**

**3) Circulation Process: IB→IR→RB = IBIRRB = Circulation System**

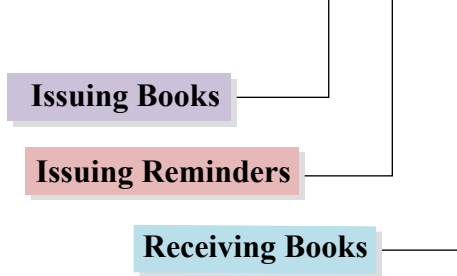

**Fig 3. Circulation Process**

Referring to the above flow process charts we may say that in most of the modern libraries accessioning and cataloguing can be eliminated to reduce the volume of works.

**8.0 LIBRARY FUNCTIONS: PROCESSES AND SYSTEMS**

Every organization functions, both administrative and managerial, directed to achieve some particular

goals would form some systems when token together. Individually, each function in each system is but a process.

To render library services we have to perform three main functions, namely, acquisition functions, processing functions, and circulation functions. Each of these functions is a process, and because each of these processes begins one after another we may also say that they together make one continuous process.





**Fig 4.** Library Organization

The library functions in terms of processes and systems we mean library management and when we speak of library functions in terms of planning, organizing, staffing and controlling library systems we mean library administration [20].

The following figure will illustrate the distribution of administrative and managerial functions among the librarians at different hierarchies.



**Fig. 5.** Library Administration

## 9.0 COMPUTER USE IN LIBRARY MANAGEMENT

The importance of information is a vital resource in today’s society and cannot be overlooked. There are many activities associated with handling information such as manipulation, location, modification, and production. The technology associated with automating many of these information processing activities is known as information technology (IT). Computers have greatly facilitated automation processing.

Computers are used in almost every field and

profession to perform a large number of useful activities. Technology innovations over the last two decades have not only increased the range of technically feasible applications, but they have also reduced costs so that computers provide a cost-effective solution to a far wider range of problems than they did before. In Business, banks transfer funds electronically from one location to another by using computers. Computers are used to control inventory, and computerized robots are used to weld parts together, paint, and much more activities.

With office automation, the computer is used for word processing, electronic mail, voice storage, and forwarding, facsimile, and teleconferencing. In science and engineering, computers are helping to unlock the secrets of our universe. In health care, computers are used to keep people in shape. In the military, computers are used to plan war strategies. With artificial intelligence and expert systems, computers are used to help people locate oil and diagnose medical problems.

Except for all applications listed above, there is another major area where computer application is not so matured as they are i.e. in library management. From the ancient time, libraries are playing a vital role in collecting and storing information. The functions of a library are to acquire documents related to the user’s need, to organize and display them efficiently in various ways, and finally to make them available to the users. These functions are dictated by the objectives of the library described in considerable detail by Prof. Ranganathan in 1931 when he presented his five laws of library science. In the fourth law i.e. “save the time of the readers”. Ranganathan recognized an object relating to the internal efficiency of the library. In the corollary to this law, he further argued that while a library has objectives to maximize time loss to the user, the library management has an objective to save the time of librarians. This can perhaps be achieved by increasing the internal efficiency of the day-to-day work within the library. It is in the context of the fourth law that automating some, if all the functions of libraries are most relevant.

An efficient library management system is required to improve control over collection, to have an effective control over the entire operation, to improve the existing services as well as to introduce

new services, to share the resources among various libraries in region effectively, to avoid duplication of work and to use the services of the existing staff effectively.

In the present day context, adoption of the manual method restricts the libraries from their better utilization. Recently the Committee on Research Libraries of the American Council of Learned Societies reports “research” libraries are in serious difficulty arising from shortage of space, staff, and funds in the face of greatly increased demand for services, resulting in increased complexities in the obligations of library management. From the managerial point of view, the chaotic operational conditions caused by a combination of these problems become subject to systematic scrutiny. The solution may lie in simply adjusting present procedures or in a combination of procedural adjustments that calls calling for the application of the technological aids including the computer.

## 10.0 STANDARDS AND SERVICES

There should be setting standards for libraries to be followed at the planning and setting-up stages and for providing effective service.

### 10.1 Physical Standards

The following are considered major characteristics of a good library in regard to its physical arrangement:

**10.1.1** The library building should be designed and equipped with functional purposes point of view. When a new building is to be constructed, the librarian should be invited to work with the architect or engineer at the time plans are drawn for such a building.

**10.1.2** A centralized library offers the best arrangement for such an institution.

**10.1.3** The physical arrangement should, as far as possible, comply with the minimum standards prescribed by the authorities and, if feasible, exceed them.

**10.1.4** There should be a separate room for the comfort and convenience of the library staff. The restroom should be equipped with easy chairs and be sufficiently segregated to permit quiet and relaxation. The library should have a room for the use of students and faculty members. It should be well-furnished and equipped with suitable chairs, tables, and reference bookshelves.

## 11.0 LIBRARY EVALUATION

If there are any prescribed or set general standards of university library service, it becomes easy to apply them to facts in a particular library situation to make a fairly accurate evaluation of its conditions and need. The procedure for evaluating the service of the university library may be considered under six headings,

- (1) Administration,
- (2) Book collection,
- (3) Staff,
- (4) Finance,
- (5) Physical plant, and
- (6) Library use.

### 11.1 Administration

For a survey of library administration the following questionnaire may be used:

- a) What is the attitude of the head of the institute towards the library and the librarian?
- b) Is the staff adequate to help individual students and the faculty in providing the purposes of instruction?
- c) Does the library follow the basic principle of good administration, and is there a clearly expressed policy of library management?
- d) Is the work of the library systematically organized with proper delegation of responsibility and authority to staff members for different phases of the work?
- e) Has there been a sincere and genuine effort to assign clerical duties to clerical and student staff and to reserve the trained librarian for professional work?
- f) Is the library getting the most from its investment in bookbinding and procurement fund?

### 11.2 Book Collection

The total number of holdings of a university library cannot be a good measure for the appraisal of the book collection. Selected periodicals and reference checklists can be used with advantage to measure the quality of the collection. The evaluation should also take into account the inability of the library to supply books for which requests were made at the loan desk either by acquisition or inter-library loan system.

### 11.3 Staff

The following questionnaire may be used for evaluating library personnel:

- a) Is the size of the staff adequate for cataloguing, circulation and reference work?
- b) Is the library given adequate recognition in the academic staff of the university?
- c) Is the librarian professionally trained; if not, has he got in-service training.
- d) Is the staff morale high or low?

### 11.4 Finance

The following criteria will help to measure the financial support for the university library:

- a) The ratio of library expenditure of the university.
- b) The per-student expenditure for library services and
- c) Comparison with the expenditure of libraries in the university of similar size and programme.

### 11.5 Physical plant

The following factors may be considered in judging building and equipment:

- a) Size.
- b) Work and reader space.
- c) Provision for expansion.
- d) Arrangement of readers and materials.
- e) Work-room and librarian's office.
- f) Space for lavatory etc.
- g) Lighting, ventilation, and sound-proofing.
- h) Comfort and variety of furnishing mechanical equipment.

## 12.0 LIBRARY SERVICE EVALUATION

Evaluation is necessary for the education process. The principal as well as members of the faculty to know whether the students make effective use of books and other materials in the library and whether there is an effective library service. It is also necessary for the university administrator to assess from time to time the value of the library in the teaching program of the university. Evaluation of service of the library is necessary to discover the extent to which its resources and services support the objectives of the university and the extent and manner in which students make use of library materials and services [20].

Standard treatise on university library administration, states the following basic principles in evaluation:

**12.1** To define closely the specific purposes of the library and their relationship to the educational aims and the central objectives of the university itself.

**12.2** The evaluation process should be a university standardized system and not just a library process.

**12.3** The evaluation process must be a continuous process of appraisal and improvement of re-evaluation and re-improvement.

The continuous evaluation is necessary to measure the effectiveness and performance of the academic libraries. The following evaluation criteria are maintained of the academic for better performance.

- a) Building a library collection;
- b) Service evaluation;
- c) Measurement of user satisfaction;
- d) Human resource management;
- e) Environmental and safety system;
- f) Special service for disabilities;
- g) Various external and internal auditing related to-
  - i) Annual stocktaking;
  - ii) Library expenditure and income evaluation;
  - iii) The perfection of task completion and achieving the target;
  - iv) Performance evaluation of the employee;
  - v) Documentation and filling;
  - vi) Knowledge management;
  - vii) Software Selection;
  - viii) Use of IT in housekeeping operations;
  - ix) Library annual report.

## 13.0 STANDARDS FOR UNIVERSITY LIBRARIES

The libraries in the universities are intellectual centers organized to serve both the students and the facilities. The committee on standards for university libraries may be formulated for the following matters:

- (1) Functions of the library
- (2) Government and administrative machinery
- (3) Budgetary matters
- (4) Staff duties
- (5) Library collections
- (6) Library services
- (7) Modern technology use for the library
- (8) Inter-library co-operations

A modern librarian is an administrator of books as well as a reader's advisor. An expert reader with plenty of time to spare and spend in the library may find the books and information he requires without

much difficulty. The average reader is usually in a hurry and will hesitate to make inquiries from the librarian or his assistants. He will, at the most, consult the catalogue and get a book that may or may not supply the necessary information.

#### **14.0 SURVEY OF LIBRARY USE**

Survey of library use may be conducted to collect statistics on the use of books issued on loan for home reading on the use of books and other materials inside the library building. A questionnaire may be given to each library user entering the library on that date and he may be asked to complete it and return it to the attendant before leaving. The evaluation made on the basis of data thus collected and statistics available in the library would indicate the quality and amount of library use by students and members of the faculty and other staff in the university. After the evaluation has been made in this manner, the evaluator should suggest as to how to improve library service and to make the library more useful [1].

The following factual data should also be collected and recorded:

- 14.1** Number of staff employed in the library.
- 14.2** Number of books and periodicals.
- 14.3** Number of books circulated for a month.
- 14.4** Number of collection of library books and whether they reflect the current studies and interests of students.
- 14.5** Number of students for which the reading room or library room can manage to seat at one time.
- 14.6** Book procurement funds or annual budget allotment for purchasing of books and other printed materials.

The evaluation data so collected and records should be analyzed and interpreted and conclusions arrived at with reasonable findings. Such evaluation would reveal the condition of the library and its working and enable the administrator to know whether he has achieved the objectives and, if not, what the shortcomings are in the functioning of the library. If answers to all the above questionnaire are in the negative, this means a huge waste of money spent on buying, the librarian's time and maintaining university space and furniture. In that case, it will be better to have no library at all than to have an ill-used and ill-maintained one. But if the results are satisfactory, he will know what degree of satisfaction

has been obtained and what further improvement in the functioning of the library is necessary to fully achieve the objectives. This evaluation will further give the administrator and the librarian an opportunity to understand their weakness and strength and be clear about the steps to be taken to vitalize the library and make the services effective. The use the students make is the ultimate test of its effectiveness [1]. Practical recommendations should be made by the evaluator basing on the utmost use of the library.

#### **15.0 LIBRARY POLICY OF THE UNIVERSITY**

In Bangladesh, there is no uniform library policy in the matter of administration, control and operation of the university library, until and unless a definite policy is laid down in respect of these matters, the problems in the area would continue to create difficulties and remain unsolved.

There should be a set code of library policy which covers the following points:

- 15.1** A clear definition of the physical plants of the library.
- 15.2** A statement concerning library budgets and finances.
- 15.3** An advisory library committee functioning with maximum effectiveness;
- 15.4** A clear distinction between staffs and professional members of the library who perform their daily duties.
- 15.5** A positive role in contributing to the universities educational programme by making the library a real teaching agency.
- 15.6** A record of research or professional accomplishments comparable to those of faculty members.
- 15.7** A complete understanding between the staff and the individual administrative members on the policies and programmes of the library.
- 15.8** The maintenance of proper balance in the workload of each employee in the library.
- 15.9** A code of ethics for librarian and staff of the university library as well as a set of library rules to the government the conduct of the students and the faculty members.

## 16.0 THE LIBRARY COMMITTEE

A library committee is necessary for the interest of the smooth running of the library. It serves both as a coordinating and a policy-making body. For a university library, the Vice-Chancellor or Pro Vice-Chancellor should head the library committee and some Wings Heads and Heads of the Departments should be incorporated as its members. The Librarian is the member secretary of the committee.

## 17.0 THE FUNCTIONS OF THE LIBRARY COMMITTEE

The library committee is mainly concerned with executive planning of the administration of the library, supervision of the work of various sections of the library and solving their various problems. Its main functions are as follows:

- 17.1 To formulate library policy and objectives.
- 17.2 To frame rules and regulations for the use of the library.
- 17.3 To check the implementation of library policy by the librarian and the library staff.
- 17.4 To check library expenditures and approve estimates of anticipated expenditures, to allocate the funds to the library.
- 17.5 To find out ways and means for additional funds required for extension of library services and management.
- 17.6 To consider proposed of the librarian which require backing him up in the matter of safety in the building and property.
- 17.7 To maintain discipline and prevention of theft cases or losses are in the jurisdiction of the librarian and his staffs.
- 17.8 To consider and study the annual report submitted by the librarian.
- 17.9 To select and appoint the librarian and his staff in defining their duties privileges and other conditions of services staffing issues.
- 17.10 To oversee the work of the library and to promote its usefulness for students and teachers in fulfilling the objectives of the library.

The functions of this committee should be purely advisory, and not administrative. The committee should discuss in its meeting about the library policy and offer advices. The following library matters may be discussed:

- a) Policy on the purchase of multiple copies of books for text-book or reserve sections;
- b) Library's role in handling audio-visual materials;
- c) Allocation of book funds to departments;
- d) Supporting the library demand for additional funds;
- e) Planning extension and remodelling of the library building or planning a new library building;
- f) Library participation in interlibrary loans in the region;
- g) Staff status to be discussed in form of the equalizing within the universities periphery;
- h) Rules and regulations regarding the functioning of the library;
- j) Methods of promoting library use by students.

## 18.0 CONCLUSION

Knowledge, skill, and aptitude are key factors in the quest for sustainable human development. Bangladesh has to be a part of this quest. Universities are a mirror of a nation and the tool to measure the depth and quality of knowledge. Unfortunately, many public universities in Bangladesh have fallen below regional and international standards. These institutions are faced with multifarious problems. A library is the main problem in universities in terms of knowledge sharing.

In view of the importance of the library in higher education. A modern university in the home must have a well-planned and functional library so that it becomes an intellectual hub of the institution both for students and teachers. Such a library will then become a temple of learning with the librarian as its priest, who must invite in that temple seekers of knowledge to enjoy an intellectual feast in a calm and serene atmosphere from the choicest collection of books and periodicals arranged systematically in open shelves.

Librarianship is now both an art and a science and the job of the librarian is no longer clerical or mechanical, it is all about technical and intellectual, and administration in nature. It is technical in relation to the organization at set up and it is intellectual in relation to the "Reference Service" to readers and the teaching staff. The administrative duties involve scientific principles of the library where it is different than the administrative aspects of other institutions.

## 19.0 RECOMMENDATIONS

**19.1** Book selection systems in the universities should be standardized. The responsibilities of the library staffs and the faculty members should be clearly spelled out. The librarian should bring publications to the notices of the faculty members. The faculty members should recommend their purchase considering the needs of the students.

**19.2** To ensure proper selection of books, a survey of reading tastes and needs of the students should be considered.

**19.3** To avert students from using cheap assistance and notes the university library should provide numerous copies of textbooks.

**19.4** To incorporate group discussions, our teaching methods should be modernized. For this reason, the libraries should be equipped considering the requirement of the students.

**19.5** To generate an interest in books and other reading materials, the students should be enabled to participate in the realm of education.

**19.6** Our teachers should recommend the books written in easy language to wipe out the difficulties of students in understanding books that are written in difficult English.

**19.7** Library materials like an encyclopedia, dictionaries, bibliographies, and other reference books should be organized in such a way so that it creates interest among the readers in using the library.

**19.8** To foster the utmost use of books, the library should be sufficiently crewed in light of rules and regulations of the University Grant Commission (UGC).

**19.9** To allow free access to books and journals, the library should be perfectly organized and assistance may be rendered in university libraries.

**19.10** To infuse library culture among the students; the librarian and faculties should work relentlessly to instigate the listed items in the classrooms.

**19.11** To popularize new books among the students and faculties; reviewed books should be exhibited on display board or may be published in universities journals and magazines.

## References

- [1] Ahmad, Shamim, Computer in Library Management, APH Publishing Corporation, New Delhi-110 002.
- [2] Bishobiddaloy Campus, May-2006 Issue, Dhaka.
- [3] Bishobiddaloy Campus, June-2002 Issue, Dhaka.
- [4] Denton, Emil Miller (Editor), Library of Tomorrow, A.L.A. Chicago, 1937.
- [5] Dusaker, Herman (Editor), Function of the Library in the Modern College, University of Chicago.
- [6] Gidwani, N.N. (Editor) Foundation of Library Science, Sabs Publishers, Bombay, 1968.
- [7] Haimann, Theo, Professional Management: Theory and Practice, New Delhi, Eurasia Publishing House, 1976.
- [8] Higher Education in Bangladesh: Present and Challenges by Prof. Monirul Haque, The Guardian, Issue-2, Vol-15.
- [9] Immelman, R.F.M, Foundations of Library Management
- [10] Lock, R.N, Library Administration, Crosby Lockwood and Sons Ltd, London, 1961.
- [11] Lyle, Guy R, Administration of the College Library, H.W. Wilson Company, Newyork, 1955.
- [12] Mukherjee, Subodh Kumar, Development of Libraries & Library science in India, The World Press Ltd, Calcutta-1969.
- [13] N, Vasantha and Mudhol, Mahesh V, Software Packages for Library Automation, Ess Ess Publications, New Delhi-110 002.
- [14] NDC Journal, Vol-2, Number-1, June-2003.
- [15] Randall and Goodrich, Principle of College Library Administration, A.L.A., Chicago, 1941.
- [16] Ranganathan, S.R. Library Administration, Asia Publishing House, Bombay, 1959.
- [17] Rao, B.V.R, Administration and Organization of College Libraries in India, Sterling Publishers (P) Ltd, 1969.
- [18] Report of the University Education Commission (1948-49), Ministry of Education, Government of India, New Delhi.
- [19] The Guardian, April-2005
- [20] Uddin, Md. Moslem "Libraries in Science and Technological College and Universities", published by The Daily Independent April 28, 2006, Page-10, May 5, 2006, Page-10, and May 12, 2006, Page-10.
- [21] Wahiduzzaman, M., Approach to Library Administration, University Press Limited, 1980.
- [22] Yearly Report-2004, University Grand Commission.
- [23] [https://en.wikipedia.org/wiki/Academic\\_library](https://en.wikipedia.org/wiki/Academic_library)
- [24] <https://www.igi-global.com/dictionary/use-cmc-technologies-academic-libraries/229>

# SPATIAL ANALYSIS OF THE INTEGRATION CORE OF COMILLA CITY CORPORATION AREA AND THE IMPACT OF THE BY-PASS ROAD - A SPACE SYNTAX ANALYSIS

**Ishrat Zerine Hossain Mou**

Assistant Professor, Department of Architecture, Stamford University Bangladesh  
E-mail: zerin14@gmail.com

## ABSTRACT

Urban area changes according to different uses of space and movement with the passage of time, as seen in land use, road network etc. Urban morphological transformation constantly remains under succession. The urbanization process substantially increases the demand for urban services such as transport, on whose efficiency and availability, the successful and continued existence of urban society depends. Transportation has a strong influence on the spatial structure at the local, regional and global levels. Historically, both social and economic growth within civilizations, have been structured by routes of travel. Thus, it is not surprising that a city's circulation system has become an important facet in today's communication-oriented urban life. Adequate transportation facilities are vital to promote growth, manage the effects of development and protect and improve city's quality of life. The paper is intended to analyze the present land uses of Comilla city (area under the newly formed City Corporation) by drawing axial lines over the collected base map and identify the integration core of the city, in relation to the introduction of the Dhaka – Chittagong by-pass road. The town though facing tremendous pressure of haphazard development, has the scope for suggested and designed development through rigorous surveys and analytical methods using space syntax analysis. This study helps to assess the spatial impact of introducing a by-pass road on the existing physical city in relation to its functional organization.

**Key words:** Comilla City, Integration core, Impact, By-pass road, Space syntax.

## 1.0 INTRODUCTION

### 1.1 Introduction

The trend of urbanization is very high in all the cities of the world. With the accumulation of variety of activities in a city, the issue of land use gets significant in terms of efficient use of the spaces and activity. Along with this issue, another unavoidable issue for proper urban development is accessibility or street network. In any area, whenever movement initiates, that is, spatial accessibility is provided, different land use generates. Different type of agglomeration generates different types of movement, for which a city has different types of land use and zoning. The basic relationship of spatial configuration – an output of street network and land use generation, helps to understand a city and guide its land use planning.

Transport system provides one of the basic

infrastructures and acts as a prerequisite for socio-economic development of a country. The history of transport development all over the world is a process of gradual evolution. Bangladesh is not an exception in this regard. Over centuries a varied and complex transport system has developed in this country on account of its various geographical features and historical facts. Transportation has always played an important role in influencing the formation of urban societies. The initial settlements were relatively small developments but with due course of time, they grew in population and developed into big cities and major trade centers.

### 1.2 Objectives

This paper aims to investigate the morphological structure of Comilla City in order to use the knowledge as a basis of future development plan of the newly formed City Corporation of Comilla.



Brief narrations of the objectives are as follows:

- Integration core in relation to land use of Comilla city.
- Assessing the impact of Dhaka-Chittagong by-pass on land use of the city in the context of present spatial organization.

### 1.3 Methodology

The study is conducted in three phases. Firstly, available literatures are reviewed to understand and explain the generation and growth of Comilla city with the passage of time. Secondly, existing land use pattern is analyzed using the map collected from Comilla City Corporation and physical survey; reviewing different published literatures on Comilla district and the city; and finally data collected from visual survey and interviews with concerned personnel of Comilla City Corporation. The base map is collected from Comilla City Corporation office, previously known as Comilla Municipality. Finally syntactic analysis of the city using Space Syntax (Depth map1) is done to get the existing spatial integration pattern of the whole city. Then combining the syntactic measures a conclusive analysis is drawn to understand the relation between the changes in land use pattern and the change in the integration pattern with the introduction of the Dhaka – Chittagong by-pass road.

### 1.4 Limitations

Since Comilla Municipality has recently been converted to a City Corporation, enough primary data, like different base maps, area development plan, etc. were not available, which could have increased the depth and diversity of the study.

## 2.0 OVERVIEW OF THE STUDY AREA

### 2.1 Background of the City

Comilla District (Chittagong division) with an area of 3085.17 sq km, is bounded by Brahmanbaria and Narayanganj districts on the north, Noakhali and Feni

districts on the south, Tripura (state of India) on the east, Munshiganj and Chandpur districts on the west. It lies between 23°02' and 23°48' north latitudes and between 90°38' and 91°22' east longitudes. The total area of the district is 3146.30 sq. km. (1214.79 sq. miles) including 6.79 sq. km. forest area.

Comilla District was established as Tripura in 1790. It was renamed Comilla in 1960. The district consists of 16 upazilas, 181 unions, 2473 mauzas, 3532 villages, 10 paurashavas, 99 wards and 296 mahallas. The upazilas are Comilla Adarsha Sadar, Barura, Chandina, Daudkandi, Laksham, Brahmanpara, Burichang, Chauddagam, Debidwar, Homna, Muradnagar, Titas, Comilla Sadar Dakshin, Monogarganj, Meghna and Nangalkot.

Comilla town is the administrative center of the Comilla District, under Chittagong division of Bangladesh and stands on the bank of river Gomuti. Comilla City Corporation is a self-governed municipal administration in Bangladesh that administers and oversees development and maintenance works in the city of Comilla. The corporation covers an area of over 33 square kilometer where over five million people live as permanent residents.

Comilla is a city in eastern Bangladesh, located along the Dhaka-Chittagong Highway at 23.4615392N and 91.1811161E. It is the administrative center of the Comilla District, part of the Chittagong Division. Comilla City Corporation (Fig. 01) stands on the bank of the Gumti River. Previously Comilla town was under Comilla municipality till the body was declared as Comilla City Corporation by a ministry of local government on 10 July 2011. It has an area of 53.04 sq km, which consists of 27 wards, with a population of 337,516 in 68181 households and 82 surrounding mouzas with a population of 187,634 in 41,320 households (BBS 2011). According to the government gazette, the new City Corporation consists of areas in the Comilla Municipality and Comilla Sadar (South) Municipality.

<sup>1</sup>Depthmap is a single software platform under the umbrella term 'Space Syntax'. It is used to perform a set of spatial network analyses designed to understand social processes within the built environment. It works at a variety of scales from building through small urban to whole cities or states. At each scale, the aim of the software is to produce a map of open space elements, connect them via some relationship (for example, inter-visibility or overlap) and then perform graph analysis of the resulting network. The objective of the analysis is to derive variables which may have social or experiential significance.

### 2.3 Land Use Pattern of the City

Comilla town has experienced substantial physical growth during last thirty years due to rapid population growth and rapid urbanization. At present the existing city portrays an organic morphological pattern which has been developing without any planning proposal. Comparing previous and present land use map (Fig. 01) it can be concluded that areas to the west, south-west and east, in particular the municipality, have been transformed into urban and semi-urban environments from their rural settings. The existing city area has obviously been unable to accommodate all the inevitable urban physical growth. Infrastructure and civic amenities are moderately well in the area.

The land use pattern of the city is quite diverse in nature. Predominantly residential areas cover 54.44 % of the total area of the city, commercial land use cover 6%, whereas educational facilities, government offices, industrial buildings, mixed use and non-government offices accounts for 1.73%, 1.61%, 1.23%, 0.04%, 0.04% respectively. Transportation and communication facilities accounts for 0.18% of the total land use cover. Agricultural and water body use are also influential which are 11.85 % and 9.2 % respectively (IDP 2017-2018, CoCC).

The city, under the city corporation authority, comprises of 27 wards, which includes former Comilla Sadar and South Municipality. The main activity hub, lies within wards no. 2, 5, 6, 10, 11 and 12, which portrays as the main town center (IDP 2017-2018, CoCC) (Fig. 01 & 02). The land use map of Comilla City (Fig. 01 & 02) shows that business areas in the Comilla City has been developed through one direction. Lots of shops, banks, insurance, restaurant and markets have developed near A K fazlul Haque road. The progression started from the “Kandir par mor” (node). This commercial development (Fig. 02) continues to Chowk Bazaar Bus Stand. In the northern side of Comilla City there is another bus stand named “Sasongacha”. There is also some development between the “Kandir par Mor” and the Sasongacha bus stand.

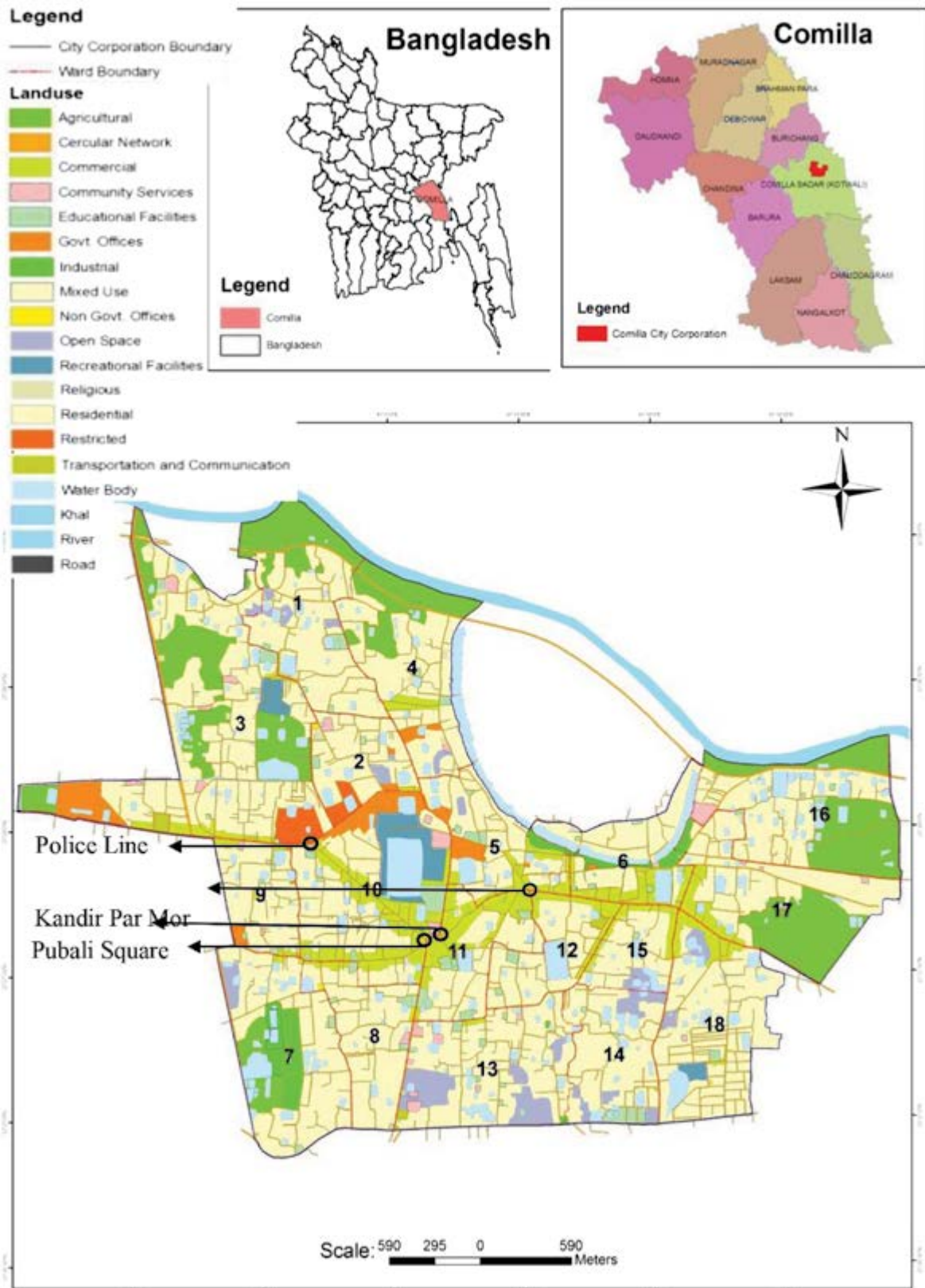

**Fig 01.** Land Use Map with the Four Important Nodes of Comilla City  
**Source:** Local Government Engineering Department (LGED)

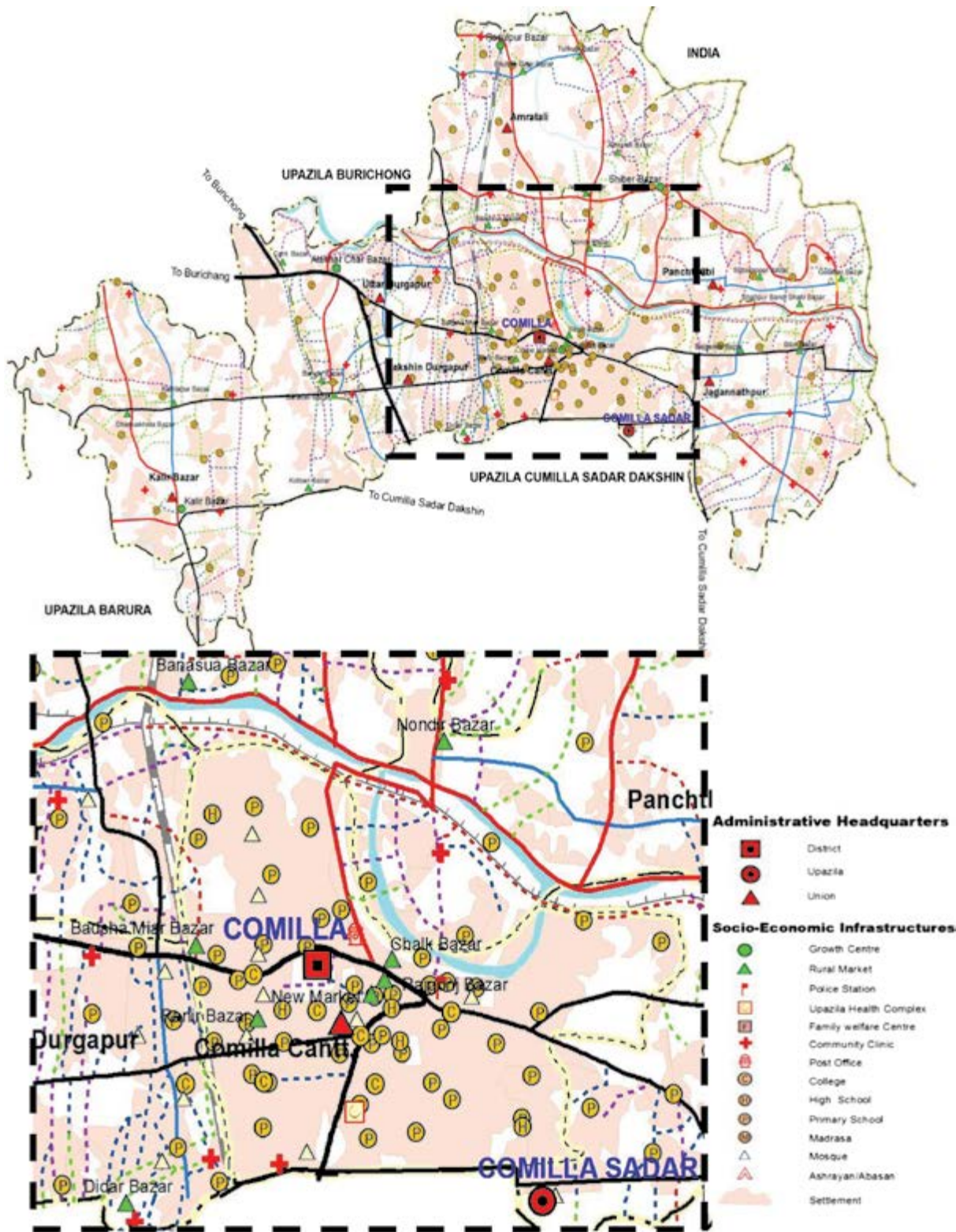

**Fig 02.** Map showing Important Infrastructures along the Four Nodes  
**Source:** Local Government Engineering Department (LGED)

### 2.4 Road Network

Comilla is known as the hub of road communication for the eastern part of Bangladesh. It is the transit point between Dhaka-Chittagong routes. The

communication system is very much sound throughout the region, particularly internal road communication systems of the eastern part has enormously developed in last decade. One of the



oldest highways of the Indian Sub-continent, 'The Grand Trunk Road', passes through the city. Historical Grand Trunk Road is used to communicate with the port facilities of Chittagong. Comilla's Court Road is an extension of historical Grand Trunk Road. At present, the most important Dhaka-Chittagong highway bypasses the city from the Comilla Cantonment to Poduar Bazar. Center point of Comilla is located 97 kilometers away from the capital city, Dhaka, which can be traveled by road or railway. Comilla also has a domestic airport situated in the Comilla Shadar Dakshin. Comilla has a total of 1219 km asphalted or paved road, 587 km of mud road and 108 km of railways. Rickshaw pulled by rickshaw pullers and CNG's are widely used. In recent years the battery-driven auto rickshaw has become very popular, mostly because of its convenience in short distance commutation throughout the main town. There are no parking facilities available for Auto Rickshaw, CNG, Rickshaw, and Trucks within the City Corporation area. There are three bus terminals located in the city corporation area: Jangalia bus terminal, Chakbazar bus terminal and Sasongacha bus terminal, but no designated intercity bus service exists there.

The main city center is termed as "Kandirpar Mor" (Fig. 03 & 04). The busiest AK Fazlul Haque Road (Fig. 03 & 04) starts from here. The main business district of the town is developed towards east moving with the AK Fazlul Haque Road. The road continues to Chawk Bazaar and after being intersected by "Thana road" and "Bazrapur road" at another nodal point is created, termed as "Razgang Chattar". The AK Fazlul Haque Road on the west and the Chawk Bazar Road in the east actually lies within the "Comilla- Chittagong By-pass Road" (Fig. 03). The "Kandirpar Mor" connects towards west with the second essential node named "Police Line Mor". This node has a major influence on morphological characteristics of Comilla City as it is being intersected by the new "Dhaka-Comilla-Chittagong Bypass Road". Before the establishment of this road, Comilla City was connected with Dhaka-Chittagong Highway through "Abdul Malek Road" (Barura Road). Another road named "Dr. Akhter Hamid Khan" act as a boundary line for the city as it has subtracted the EPZ and industrial zone from the city.

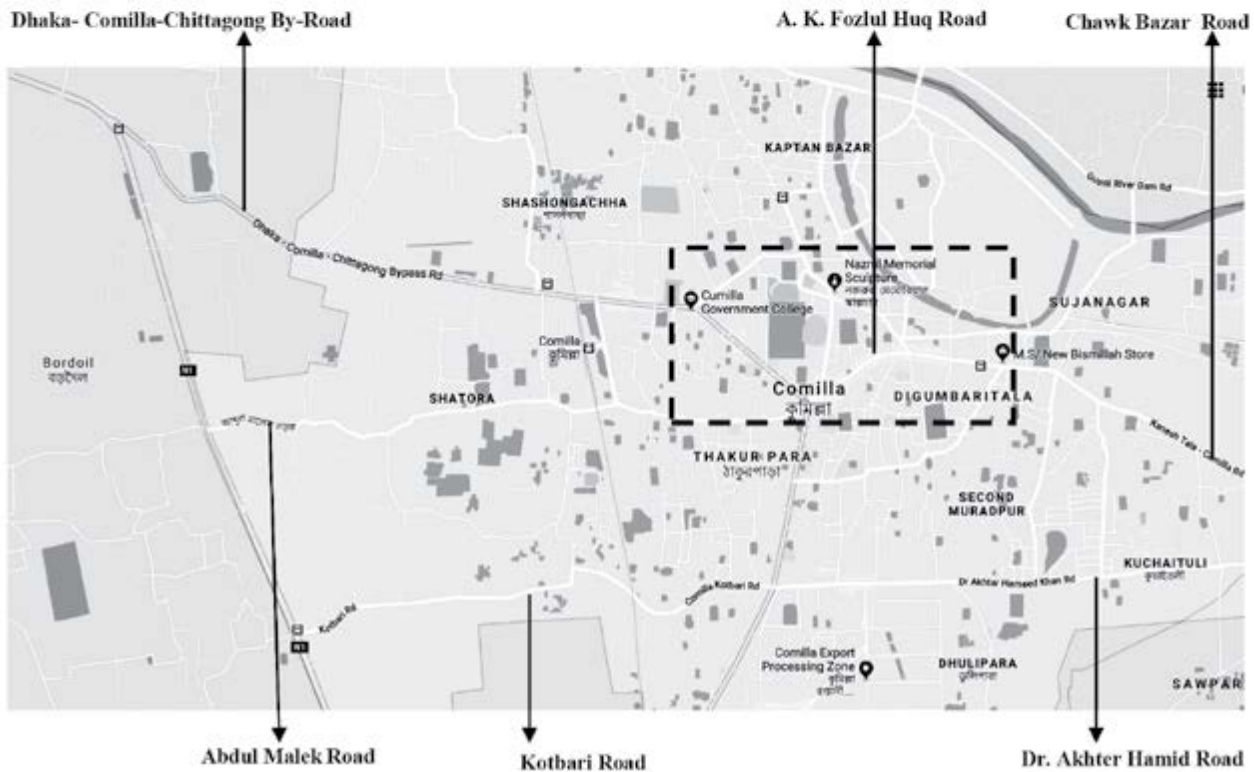
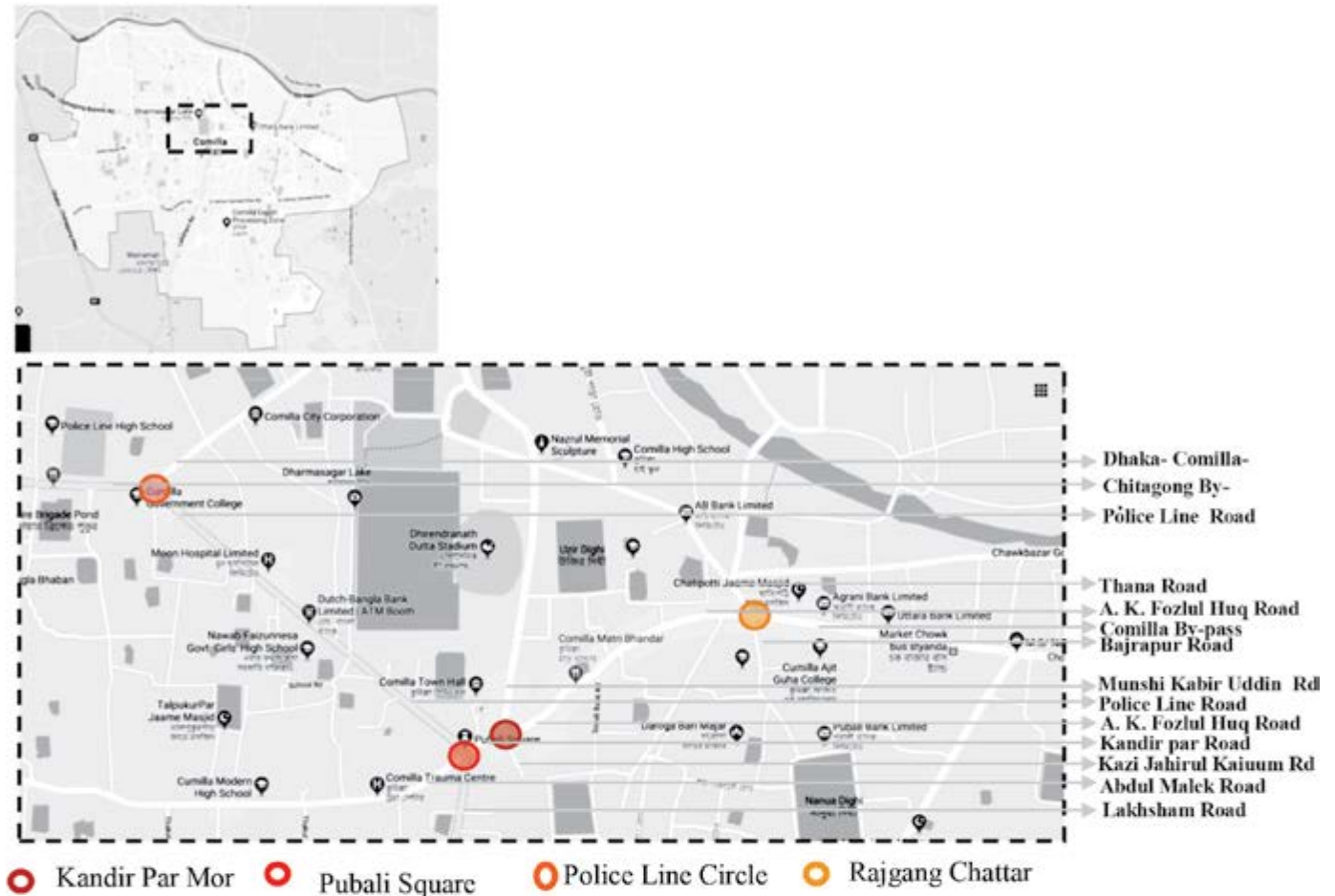

**Fig 03:** Map showing Important Roads and Connectivity of the Four Important Nodes  
**Source:** Google Earth



**Fig 04.** The Four Important Nodes of Comilla City

### 3.0 ANALYSIS

#### 3.1 Spatial Analysis of Comilla City using Base Map and Visual Survey

Physically the city center of Comilla is located mainly comprising Ward no. 10 and partially ward no. 2, 5, 6, 11 and 12 (IDP 2017-2018, CoCC) (Fig. 01 & 02). The Kandirpar Pubali Square (Fig 1 & 5b), near Dharma Sagar, located within the city center, is perhaps the busiest node of the city, consisting of four roads: Shahid Nizamuddin Road (also known as Police Line Road), Kandirpara Road from the west, Lakhsham Road from the south and AbdulMalek

Road from the west. The Kandirpar Mor, located very near to the Pubali Square, seems to be the second busiest node. It is formed by the Kandir par Road, Shahid Kabiruddin Road (Zila School Raod), A. K. Fozlul Haque Road and Kazi Johurul Kaiuum Road (also known as Ranibazar Road), the road leading to the famous Victoria College (one of the landmark of Comilla City) (Fig. 01, 02 & 5a,b). Many important developments, particularly commercial and administrative developments, are noted beside these five roads, especially beside the Laksham Road, Shahid Nizamuddin Road and Shahid Kabiruddin Road (Fig. 03). Most of the public



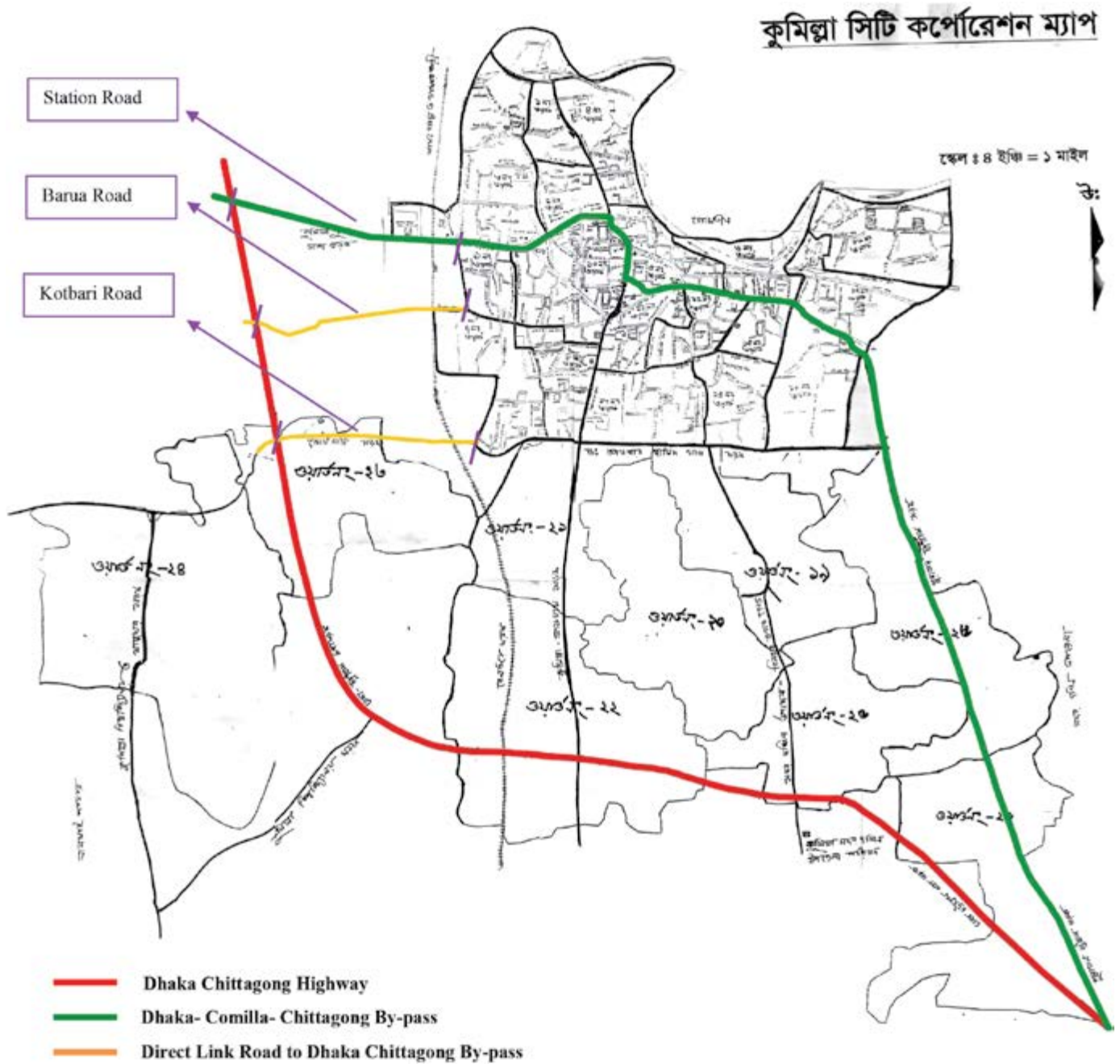

**Fig 05a.** Base Map (used for syntactic analysis) showing areas under Comilla City Corporation, Old Trunk Road, Dhaka Chittagong By-pass and its direct link roads to City  
**Source:** Comilla City Corporation

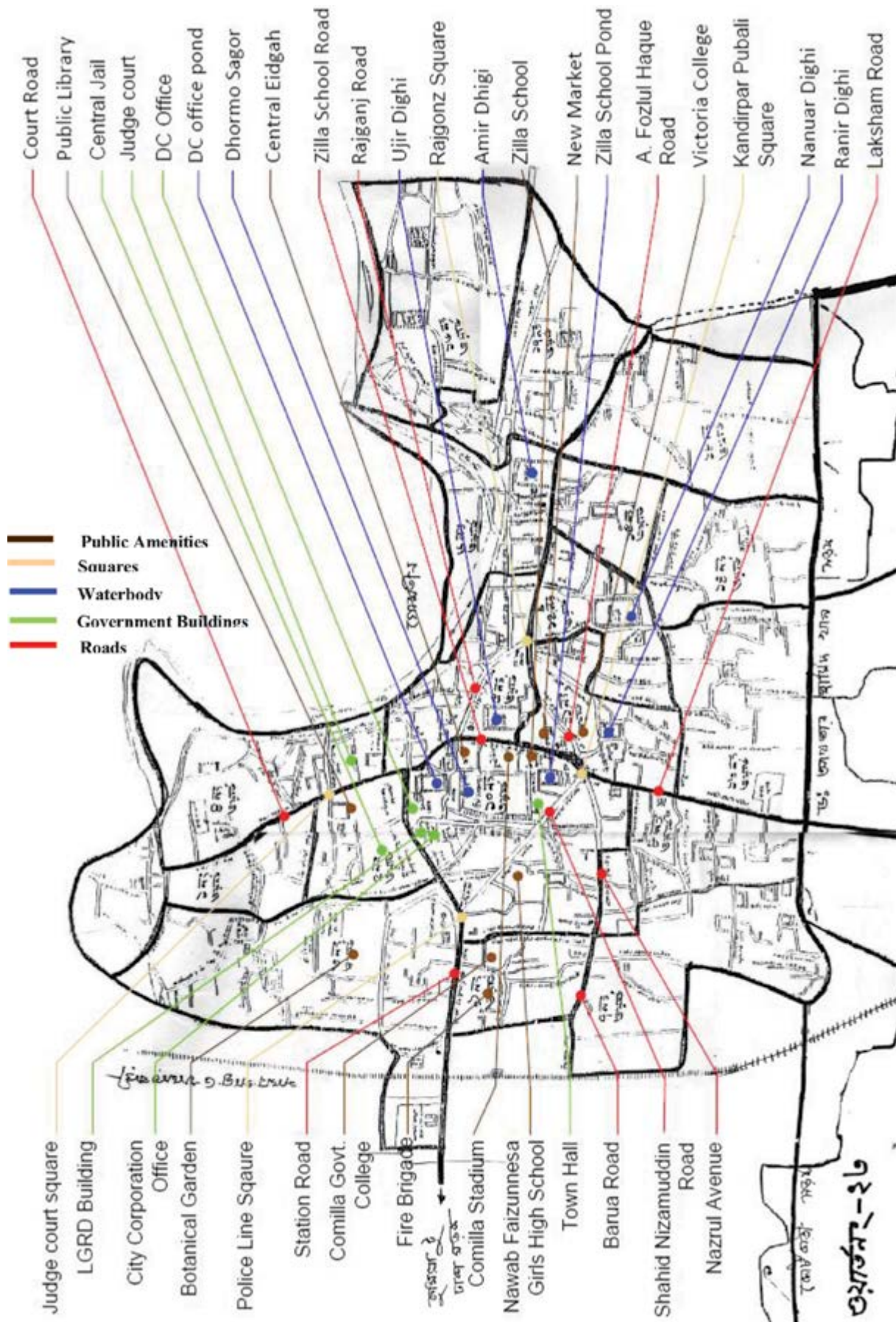

**Fig 05b.** Land Use Map showing areas under Comilla City Corporation  
**Source:** Comilla City Corporation Map edited with Names

administrative buildings, like the City Corporation Office, LGRD Building, DC Office are situated in ward no. 10, surrounding the famous Dharma Sagar (Fig. 03). Many other civic amenities like Pouroshova Park, Central EidGah, Town Hall, Comilla Stadium, Zilla School, Comilla Hospital, and New Market are also located within this ward. Another important node is the Police Line Square, perhaps the second busy node of the city. It is formed by the intersection of Shahid Nizamuddin Road, and Burichong Road (Station Road) (Fig. 01, 02 & 5a,b). Structures like Comilla Government College, Nawab Faizunnesa Girls High School, Central Jail, Fire Brigade, etc are located besides these roads. There is another square on the east known as the Rajgonz Square. It constitutes the Comilla Bypass Road from the east, the Bajrapur Road from the south, the Thana Road and the A. K. Fazlul Haque Road from the west (Fig. 01, 02 & 5a,b). The Abdul Malek Road, bearing the name of Barua Road on the east and the Station Road on the west ultimately meet the Dhaka Chittagong Highway. Comilla-Chittagong railway, near ward no. 7, runs through the western part of the town. Considering goods transportation and physical accessibility both by the road and railway the west and south-west part has major urban development prospects. The city is connected directly to the Dhaka - Chittagong Highway by two link roads: the Abdul Malek Road and Kotbari Road on the west. Station Road on the south meets the Dhaka - Chittagong By-pass, at a point close to the Dhaka - Chittagong Highway and the Dhaka - Chittagong By-pass. Dr. Hamid Khan Road connects with the Dhaka - Chittagong By-pass from the east (Fig 03 & 05a,b).

## 3.2 Space Syntax Analysis (Depth Map)

### 3.2.1 Space Syntax

Space syntax, from its origin in urban research, proposes a language of space that could be of interest for many research and application areas involved in the description and analysis of spatial patterns. Space syntax provides a method for partitioning a spatial system into relatively independent but connected subspaces so that the importance of these subspaces can be measured in terms of their relative nearness or accessibility (Hillier and Hanson, 1984).

The techniques – and the theories – of space syntax are based on two key propositions. The first is that space is not a background to human activity, but intrinsic to it, that is each kind of human activity has its own natural geometry (Hillier, 2014). The

second proposition is that space is first and foremost configurational, that is space has simultaneously existing relations (Hillier, 2014).

The space, in configuration analysis, starts with the representational techniques. In this technique ‘convex spaces’, defined by polygons where no line drawn between any two points in the space goes outside it; ‘axial lines’, defined as the longest and fewest straight lines of visibility and permeability that cover all the convex spaces, represent the one dimensional organization of the spatial layout (Hillier & Hanson, 1984).

In the context of a city, urban blocks or plots are considered as closed spaces, while streets and squares as parts of the open space. Open space provides a unique vision in understanding the configuration of an urban system. ‘Syntax maps’, based on the open spaces, provide a precise skeleton representation of an urban configuration and a reference for analytical measures. (Jiang & Claramunt, 1999). The maps are, namely, axial maps, convex maps, isovist maps etc. In axial analysis for cities, space syntax models work by taking the pattern of full street network and analyzing it with mathematical tools.

Based on the syntactic maps, a series of measures of the properties of the configuration of the street grid are derived. The four first order measures are Integration, Connectivity, Control and Choice among which the first one is the most important of all. The ‘integration’ of a space is a function of the mean number of lines and changes of direction that need to be taken to go to all other space in the system. Integration is therefore about syntactic, not about metric accessibility and the word depth rather than distance is used to interpret how far a space lies. The integration value of a line is a mathematical way of expressing the depth of that line from all other line in the system (Hillier & Hanson, 1984). The spaces of a system can be ranked from the most integrated to the most segregated.

Global Integration provides a global index of relative integration and segregation for that line relative to all others. Values well below 1 — of the order of 0.4 to 0.6, indicate more segregation and; while the value ending to and above 1 show strong integration. Warmer color axial line has, high global or local integration value, vice versa (most integrated roads



in red and least integrated roads in blue). Local integration relate to the spatial properties of space up to three steps ( $R=3$ ) away from the root. It is conjectured that part of the urban grid are differentially connected within and between themselves, which should be revealed by the rank order of the local integration value. Integration core is the set of the most integrating spaces of a system (Nilufer, 1997). The configuration of that core can be fully connected or split, which is an important property of layouts.

It is also possible to develop second order measures by correlating these four first order measures. Intelligibility, for example, is the correlation between connectivity and integration and describes how far the depth of a space from the layout as a whole can be inferred from the number of its direct connections, i.e. what can be understood of the global relation of a space from what can be observed within that space.

### 3.2.2 Syntactic Analysis of Comilla City

In this section, syntactic analysis of Comilla City is carried out to assess the global integration core and the existing center of the city and to understand accessibility and connectivity issues of the global integration core with and without the Dhaka - Chittagong bypass. Based on the existing map of Comilla City Corporation (4" = 1 mile) an axial map for the city has been produced and analyzed using depth map to reveal the spatial attribute of the city. As mentioned before, Comilla is an organic city and it has a lattice or mesh like road network. All the arterial, sub-arterial and most of the collector roads are considered here. Because of the curvilinear nature of the roads, axial lines could not be continued very long. Most of the portion of the axial map is fragmented in character.

#### 3.2.3.1 Analysis without considering the by-pass road

Syntactic analysis of Comilla city with radius 'n' is given in 'figure 7'. It is a derivation of the process in which each line is picked up in turn and the complexity distance or depth is calculated to all other lines in the system. For this study 5% integration core is considered. Here the range of global integration ( $R_n$ ) value of the system is from ( $R_n= 1.07$ ) to ( $R_n= 0.88$ ). The map shows a color variation from red to blue. In this analysis of Comilla city, the shallowest lines, which means the lines with the lowest total of depth and highest integration value, coincides with

the previously mentioned city center (Kandirpar Pubali Square), running through the city from the south towards north up to Ward no. 2 and to Ward no. 5, 11, 12 and 6 in the west.

#### 5% integration core (5% of 980) = 49 lines (Range: 1.07254 to 0.87941)

In this part the direct connections with the Dhaka - Chittagong by-pass (using Sation road and Barua Road) are omitted to assess the state of integration core with respect to only the internal movement within the city. The red colored lines, around the Kandirpar Pubali Square, is the highest integrated core of the city for radius-n ( $R_n$ ). It is more or less in the visual center of the city area (Section 3.1, Fig. 02 & 03). A blown up drawing of the core is given in Figure 7. From the axial map analysis of Comilla city, without considering the by-pass road, it is found that the most integrated roads of the city are A.K. Fazlul Haq road, Shahid Nizamuddin road, Shahid Kabir Uddin road, Laksham road, Station Road, Burichong Road, Dr. Akhter Hamid Khan Road, etc. Collectively these roads can be termed as the global "Integration core" (Fig.7). Integrated roads attract more traffic movement that means more accessibility can be ensured in these roads. Total numbers of line is 14756 and summarized values of some measures of those lines are given below in Table 1.

**Table 1.** Attribute Summary

Attribute	Minimum	Average	Maximum
Integration	0.276708	0.631118	1.07254
Connectivity	1	2.85918	15
Mean Depth	7.86517	13.5122	27.6098
Node Count	980	980	980

From the syntactic analysis without considering the by-pass road and the existing spatial formation of road network, it can be established that the roads with high integration value are functionally very important for the city and have better accessibility, so used intensively by the city dwellers. It is also found that different administrative, cultural, educational buildings and many other civic amenities are located besides these roads, which are easily accessible and recognizable. The range of global integration ( $R=n$ ) value of the system ranges from 1.07254 to 0.87941, which is more than the mean value of 0.631118. The table below demonstrates the syntactic data along with the important structures beside the most integrated roads.

**Table 2.** Syntactic Data without considering the by-pass road

<b>Name of the access road</b>	<b>Segment (access rd)</b>	<b>Connectivity</b>	<b>Mean Depth</b>	<b>R=n (golbal integ. rad.)</b>	<b>Structures beside the road</b>
Laksham road (wrđ no. 8 & 13)	23	14	147.96	1.05712	Comilla Education board, Comilla Residential School
Laksham road (ward no. 21)	144	3	8.1951	1.02336	Comilla EPZ, Shaktola High School
Laksham road (ward no. 22)	159	4	8.77528	1.02336	Paduar Bazar Bishaw Road Jamae Mosque
Police Line Rd(Shahid Ni-zamuddin Rd)	180	15	8.400	0.994965	Nawab Fayzunnesa govt. High School, fire Brigade, Rotary Club
Dr. Hamid Khan Road	7	15	7.8652	1.07254	Comilla EPZ
Dhaka Chitagong Trunk Road (Station road)	2	11	8.978	0.922868	Comilla Central Jail, DC Office, LGED Office, Comilla City Corporation, Comilla
Station road (Dhaka Chitagong Trunk Road)	1	12	8.996	0.920864	Argrculture Department Office, Regional Passport Office
Zila School road(Shahid Kab-iruddin Road)	25	4	8.606	0.967977	Comilla Central shahid minar, Town Hall, Zilla School, Comilla Stadium
Nazrul Avenue	181	7	8.444	0.989095	Pubali Bank and Comilla kagoj
Roy Bari road	24	6	8.908	0.931093	Central medical College Hospital
Comilla Court road	29	4	10.412	0.78226	Government Public Library, Judge Court
A. K. Fozlul Haque Road	182	3	9.0633	0.920864	Kotwali Thana, Ajit guha Degree College
Shadar Hospital Road	32	7	9.7906	0.945132	Comilla Shadar hospital
Abdur Rahman Khandakar Rd	416	4	8.7681	0.947866	Comilla Govt. Women College
Thakur Para Road	183	4	8.7314	0.952375	Comilla Education Board
Chawk Bazar Rd	148	5	8.9836	0.922278	Bakrabad Primary and High School, Agrani Bank. Uttara Bank

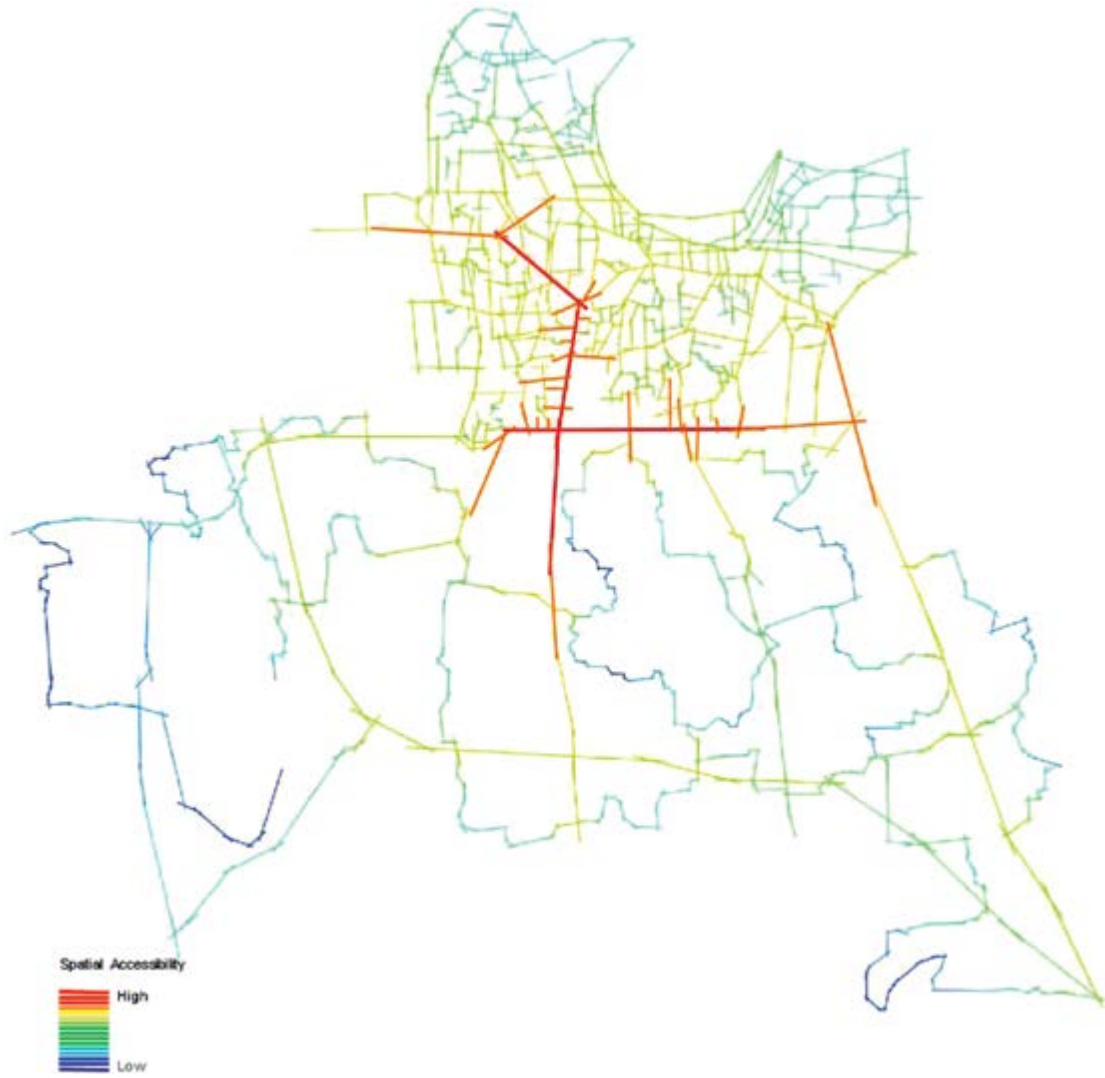

**Fig 06:** Syntactic Analysis of Comilla City without considering the By-Pass Road (R=n)

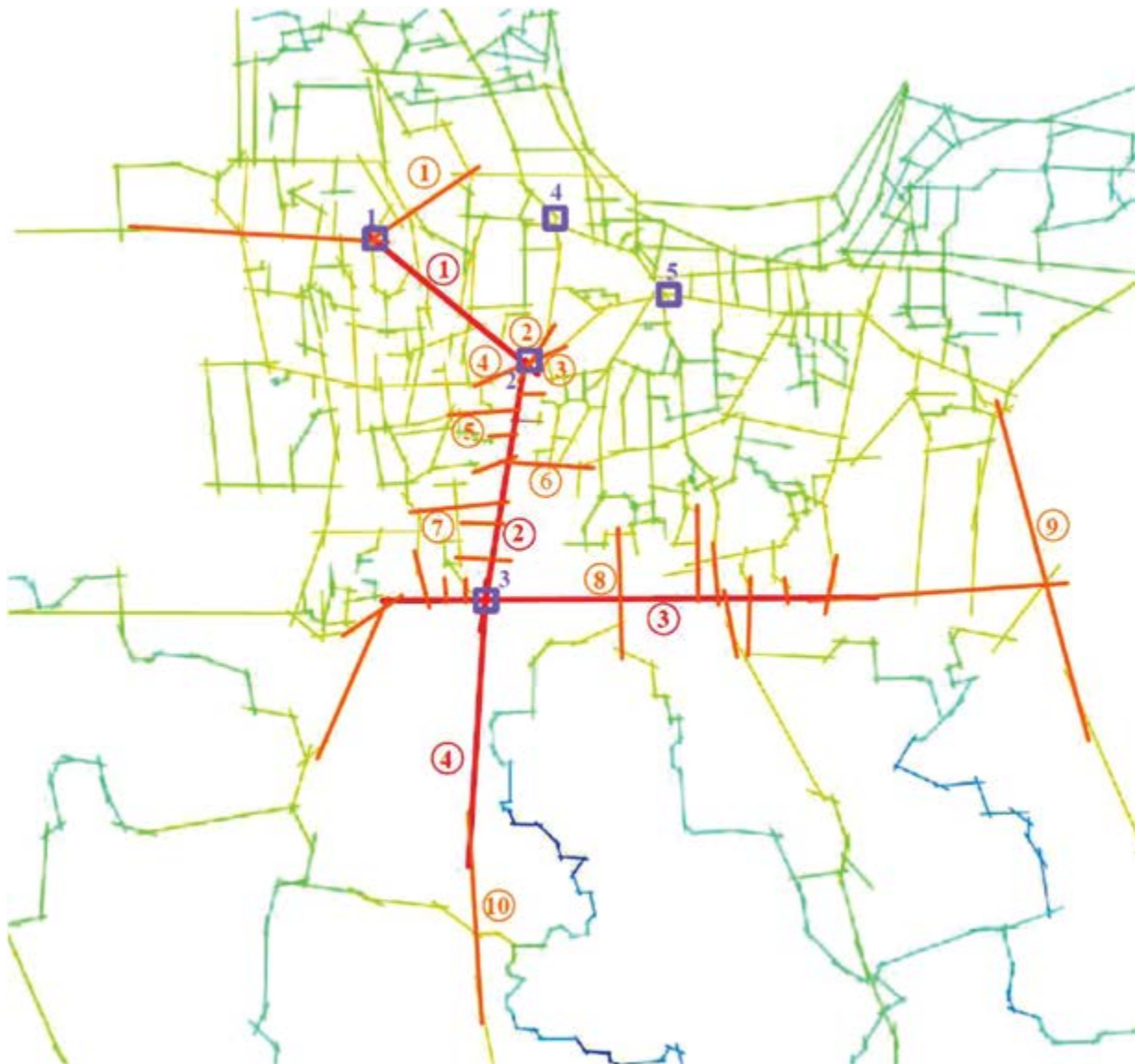

**LEGENDS**

Most integrated roads			Second most integrated roads		Squares formed by highly integrated roads		
	Name	R = n		Name	R = n	Name	
1	Shahid Nizamuddin Road	0.99496	1	Station Road	0.92086	1	Kandirpar Pubali Square
2	Laksham rd (wrđ no. 8 & 13)	1.05712	2	Shahid Kabir Uddin Road	0.96798	2	Police Line Square
3	Dr. Hamid Khan Road		3	A. K. Fozlul Haque Road	0.92087	3	Laksham Node
4	Laksham road (ward no. 21)	1.02336	4	Nazrul Avenew	0.98909	4	Court Road Node
			5	Roy Bari Road	0.93109	5	Rajgong square
			6	Shadar Hospital Road	0.94514		
			7	Thakur Para Road	0.95238		
			8	Abdur Rahman Khandakar Rd	0.94786		
			9	Chawk Bazar Rd	0.92228		
			10	Laksham road (ward no. 22)	1.02336		

**Fig 7.** Blow-up of Integration core of Comilla city without considering Dhaka - Chittagong Bypass road (R = n)  
**Source:** Produced by Depth Map



**3.2.3.2 Analysis considering the By-pass Road**

In this part, the syntactic analysis is done considering the impact of the Dhaka – Chittagong bypass road on the global integration core of the city. The axial map for this part is prepared by superimposing the axial map of the area under the Comilla city corporation and the sub-district map of Comilla (Comilla Sadar and Comilla Sadar Dakshin) collected from LGED website. Here the range of global integration value (Rn) of the system from (Rn=0.869) to (Rn= 0.730) is considered using again a 5% core. Total number of lines is 14756, whose attribute summary is given below in table 3.

**Table 3.** Attribute Summary

Attribute	Minimum	Average	Maximum
Integration	0.191847	0.536308	0.869076
Connectivity	1	2.74686	14
Mean Depth	9.68374	16.0442	40.3378
Node Count	1114	1114	1114

With the introduction of the Dhaka – Chittagong bypass road, it is found that the integration core has

slightly shifted towards the south (Fig. 08& 09). The higher integration value still coincides with the previously mentioned city center, Kandirpar Pubali Square (Section 3.1), running through the city from the south towards north up to Ward no. 2 and to Ward no. 5, 11, 12 and 6 in the west, except the newer addition of the segment of Laksham road passing through Ward no. 22 in the extreme south. Considering 5% integration core value of Rn ranges from 1.07254 to 0.87941.

**5% integration core (5% of 1114) = 56 lines (Range: 1.07254 to 0.87941)**

The integration core considering the bypass road more or less coincides with the previous integration core (Table 5), though with a variation in the extreme south of the city. From the axial map analysis of Comilla city with and without the bypass road, it is noted that exclusion of the Bypass road, and considering the Dhaka Chittagong as the only thoroughfare from Dhaka to Chittagong, has comparatively minor effect on the location of integration core of the city.

**Table 4.** Syntactic Data considering the By-pass Road

Name of the access road	Segment used as an access road	Connectivity	Mean Depth	R = n (global integration radius)	Structures beside the road
Laksham road (betwn. ward no. 8 & 13)	44	11	9.75651	0.861853	Comilla Residential School, Thompson Bridge Bus station, Ishwar Pathshala High School
Laksham road (ward no. 21)	175	3	9.68374	0.869076	Comilla EPZ, Shaktola High School
Laksham road (ward no. 22)	190	4	10.1905	0.821158	Paduar Bazar Bishaw Road Jamae Mosque
Police Line Road (Shahid Nizamuddin Road)	205	13	10.406	0.802333	Nawab Fayzunnesa govt. High School, Fire Brigade, Rotary Club
Dr. Hamid Khan Road (Chowk Bazar Road)	178	14	9.805	0.857104	Comilla EPZ, Comilla Housing State Area
Dr. Akhter Hamid Khan Road (Chowk Bazar Road)	182	6	11.066	0.749699	Comilla Medical college
Station road (Dhaka Chittagong Trunk Road)	24	11	10.9461	0.758774	Comilla Central Jail, DC Office, LGED Office, Comilla City Corporation, Comilla Govt. Public Library
Zila School Road (Shahid Kabiruddin Road)	47	3	10.6792	0.779692	Comilla Central shahid minar, Town Hall, Zilla School, Comilla Stadium

Nazrul Avenue	206	6	10.394	0.802333	Pubali Bank and Comilla Kagoj
A. K. Fozlul Haque Road	201	3	10.945	0.758842	Kotwali Thana, Ajit guha Degree College
Shadar Hospital Road	53	6	10.5472	0.790478	Comilla Shadar Hospital
Abdur Rahman Khan-dakar Road	695	5	10.6801	0.77962	Comilla Govt. Women College
Roy Bari Road	45	6	10.6164	0.784791	Ramghat Mosque
Thakur Para Road	208	4	10.4825	0.795871	Comilla Education Board

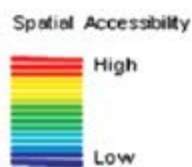

**Fig 08.** Syntactic Analysis of Comilla City considering Dhaka - Chittagong Bypass road (R = n)  
**Source:** Produced by Depth Map

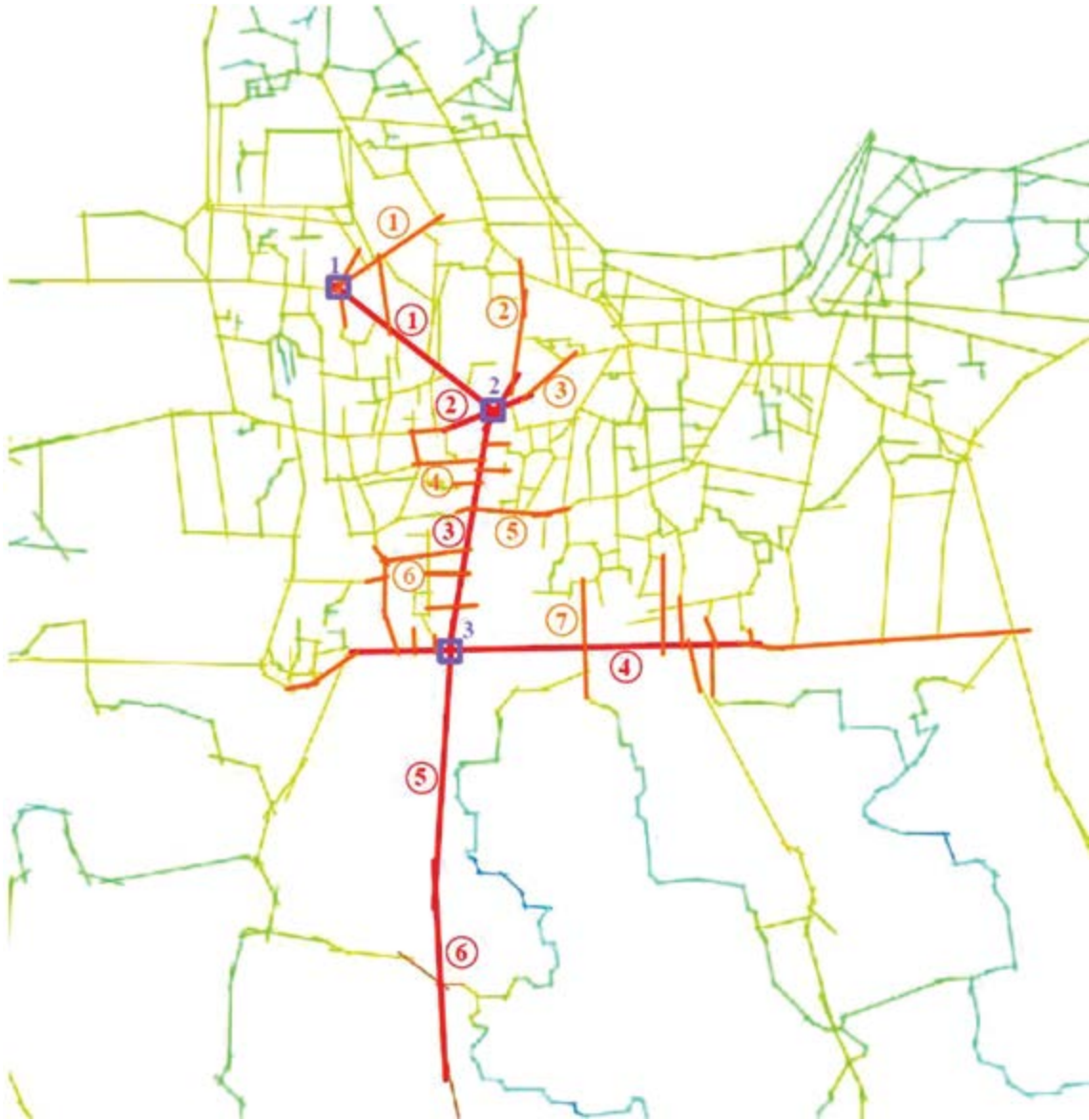

**LEGENDS**

Most integrated roads		Second most integrated roads		Squares formed by highly integrated roads
Name	R = n	Name	R = n	Name
1 Shahid Nizamuddin Road	0.802333	1 Station Road	0.758774	1 Kandirpar Pubali Square
2 Laksham rd (wrđ no. 8 & 13)	0.802333	2 Shahid Kabir Uddin Road	0.779692	2 Police Line Square
3 Dr. Hamid Khan Road	0.861853	3 A. K. Fozlul Haque Road	0.758842	3 Laksham Node
4 Laksham road (ward no. 21)	0.857104	4 Roy Bari Road	0.784791	
5 Laksham road (ward no. 21)	0.869076	5 Shadar Hospital Road	0.790478	
6 Laksham road (ward no. 22)	0.821158	6 Thakur Para Road	0.795871	
		7 Abdur Rahman Khandakar Rd	0.77962	

**Fig 09.** Blow-up of Integration Core of Comilla City considering Dhaka - Chittagong Bypass road (R = n)  
**Source:** Produced by Depth Map

### 3.2.4 Comparison

From the above analysis it is found that the integration core changes, though slightly, with the introduc-

tion of the by-pass road. A comparison of the highly integrated roads common in both the cases, with and without the by-pass road is summarized below.

**Table 5:** Comparison of Rn considering and without considering the by-pass

Name of the Access Road	Without Considering the By-Pass Road (R = n)	Considering By-pass Road (R = n)
Laksham Road	1.05712	0.861853
Police Line Road	0.994965	0.802333
Dr. Hamid Rhan Road	1.02336	0.857104
Dhaka Chitagong By-pass Road	0.922868	0.7588
Zila School Road	0.967977	0.779692
Nazrul Avenue	0.989095	0.802333
A. K. Fozlul Haque Road	0.814707	0.758842
Shadar Hospital road	0.945132	0.790478

From this table, it can be noticed that, the integration value of these eight roads varies slightly with the introduction the by-pass road in context of the whole city. Thus, it can be assumed that the flow of internal traffic is higher within the city center than compared to the traffic flow from the by-pass road (Fig. 06, 07, 08 & 09).

### 3.3 Correlation of Syntactic Measure

The correlation between global integration and connectivity shows the intelligibility of the space. It also leads to a strong sense of readability of the system. In more intelligible system, the people occupancy along the axial line is predictable from the measure of integration. That means the most integrated lines are the most intensely used path by the people and in the non-intelligible system, people occupancy rate along axial lines tend to be more random (Khan, 2008). To measure the correlation of global integration (Rn) and connectivity (CN),

points are plotted according to its degree of global integration on the horizontal axis and connectivity on the vertical axis. Depending on how well a space is connected, the axial map is colored from red to blue, the connectivity or integration. Red lines represent very well connected/integrated space and blue lines are not well connected and the most segregated, using the spectrum (red to blue) to show something in between (Jacoby, 2006).

#### 3.3.1 Correlation without considering the By-Pass Road.

To measure the intelligibility of the most integrated access road in city scale, at first the correlation value between the global integration and connectivity has been determined and then compared with the correlation value between global integration and connectivity of the particular segments used as the access roads comprising the core. Highly integrated lines are well connected.

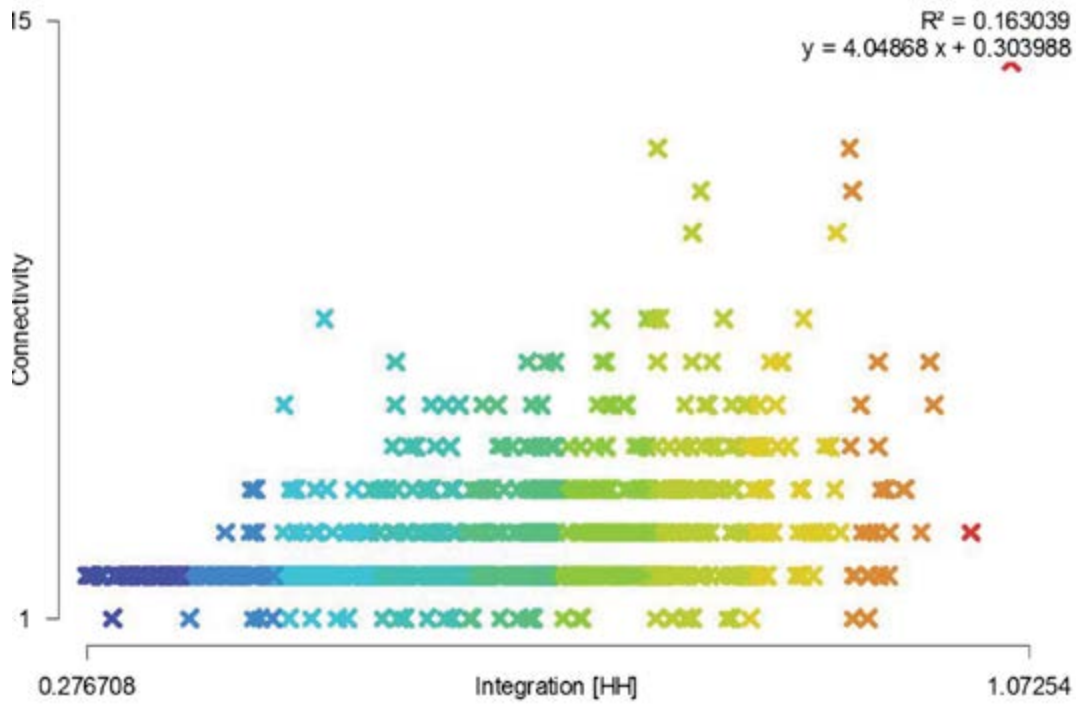

**Fig 10.** Correlation between global integration & connectivity of Comilla city without considering the By-Pass Road.

From the correlation (Fig. 10) it is found that the correlation value between connectivity and global integration of the total system is  $R^2 = 0.163$ , which is much less than the value 0.5, that indicates poor correlation and non-intelligible when the access roads are analyzed as part of the whole system.

### 3.3.2 Correlation considering the By-pass Road

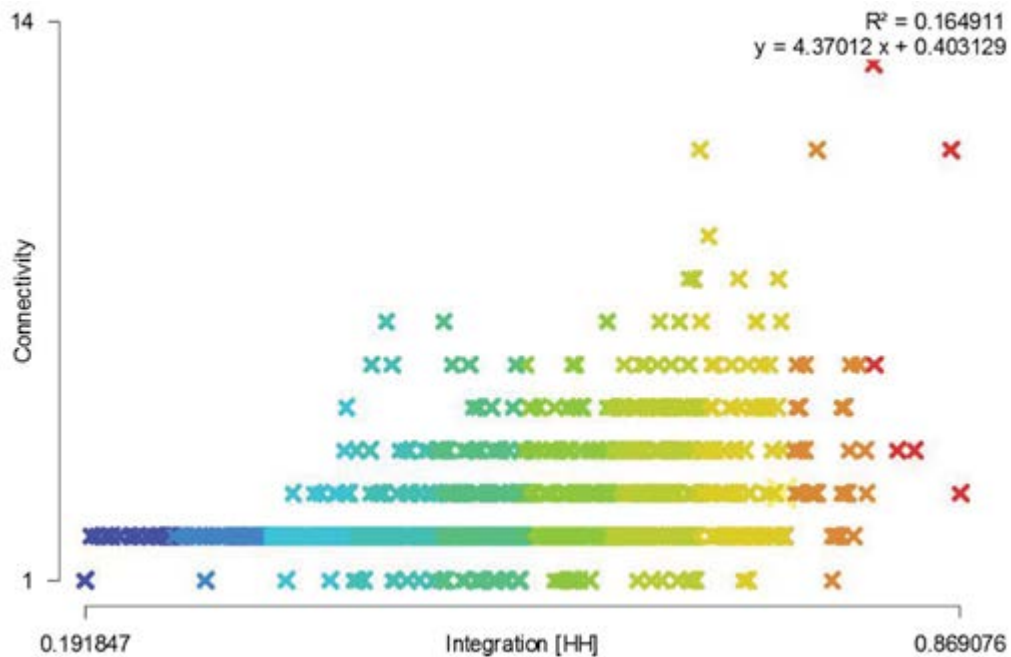

**Fig 11.** Correlation between global integration & connectivity of Comilla city considering the By-pass Road

From the correlation (Fig. 11) it is found that the correlation value between connectivity and global integration of the total system is  $R^2 = 0.165$ , which is much less than the value 0.5, that indicates poor correlation and non-intelligible when the access roads are analyzed as part of the whole system.

### 3.3.2 Comparison

From the above correlations it is seen in the correlation between global measure and connectivity that the value of  $R^2 = 0.163$  (without the by-pass road) and  $R^2 = 0.165$  (considering the by-pass road) are much less than 0.5, indicates poor correlation and non-intelligible as part of the whole system.

Correlation is comparatively negligible when the by-pass is considered. But in both the situation, the value of  $R^2$  is less than 0.5. It indicates that the city is less intangible or readable in global scale.

## 4 CONCLUSION

### 4.1 Findings

From the syntactic analysis, it is found that most of the administrative buildings and civic amenities coincide with 5% integrated roads of the city. So it is evident from the analysis that the city center has better accessibility in the city scale as all the integrated values of the access roads of the buildings are higher than the mean integration value. Mostly commercial and administrative developments (public administration), are concentrated near the main integration core of Comilla city. The global integration value of the highly integrated roads slightly increases when the by-pass road is not considered. From this it can be assumed that, in context of the whole city, flow of internal traffic is higher within the city center than compared to the traffic flow from the by-pass road.

The correlation (between the global integration and connectivity) is poor in global condition both considering and without considering the inter-city traffic. That means the city is less intangible or readable in the global context. Though the integration value increases considering the inter-city traffic through the city, the intelligibility decreases in the local context.

### 4.2 Conclusion

In the conclusion it can be said that the internal movement within the city is not at all hampered by the introduction of the by-pass road. The city becomes slightly more intelligible (readable) with the introduction of by-pass road, which is though very negligible but can be important for small scale city like Comilla. As it is seen in this research that roads surrounding the Kandirpar Pubali square coincide with the present integration core and it is and will be attracting more activities, mostly commercial and similar other land uses, future planning decisions can

be taken accordingly. The analysis shows that further commercial development will take place towards the Dhaka-Chittagong-Comilla bypass road. The result of the study will help to understand the future land use pattern and to make them compatible with the present as well as ever growing future demand of Comilla City.

The Comilla town though facing tremendous pressure of haphazard development, has still the scope for suggested and designed development through rigorous surveys, analytical methods and other virtual analysis like using space syntax for spatial network analyses to understand and predict social processes within the built environment. Both built and vacant areas along the integration core are still attracting new developments and redevelopments. In such a small urban state like Comilla, planning decisions have a lot of scope to explore a city in a properly thriving way. Syntactic analysis is a tool which can help the planners to see the unforeseen about a city.

## References

- [1] en.banglapedia.org
- [2] Bangladesh Bureau of Statistics
- [3] Bangladesh Population Census 2001.
- [4] www.dccomilla.gov.bd
- [5] IDP 2017-2018, CoCC, Updated Infrastructure Development Plan, Comilla City Corporation
- [6] Hillier, B. (2014), The Generic City and its Origins, DOI: 10.1002/ad.1815
- [7] Hillier, B. (1996), Space is the Machine: A Configurational Theory of Architecture, Cambridge University Press.
- [8] Hillier, B. and Hanson, J. (1984), The Social Logic of Space, Cambridge: Cambridge University Press.
- [9] Jiang, B. and Claramunt, C. (1999), A Comparison Study on Space Syntax as a Computer Model of Space, Second International Symposium on Space Syntax, Universidade de Brasilia, Brasilia.
- [10] Nilufer, F. (1997) The Spatial and Social Structuring of Local Areas in Dhaka City—A Morphological Study of the Urban Grid with Reference to Neighbourhood Character within Naturally-Grown Areas. Ph.D. Thesis, University College London, London.
- [11] Khan, N., (2008) Study of morphological transformation on planned residential areas of Dhaka city, unpublished M.Arch Thesis.
- [12] Jacoby, K. (2006), What is Space Syntax? Does the urban form of the city affect the level of burglary and crime?
- [13] www.dccomilla.gov.bd
- [14] www.banglapedia.com
- [15] www.lged.gov.bd



# EXPERIMENTAL INVESTIGATION ON THE IMPACT OF CONCRETE STRENGTH ON THE DUCTILITY OF REINFORCED CONCRETE FRAME STRUCTURES

**Lieutenant Colonel Bhuiyan Mohammad Golam Kibria**

Course member AFWC 2019

National Defence Colloge, Mirpur Cantonment, Mirpur-12, Dhaka-1216

E-mail: kibria1976@gmail.com

## ABSTRACT

This experiment was undertaken to study the impact of concrete strength on the ductility of reinforced concrete frame structure. Two half scale interior joint with monolithic transverse beams and slab from a six storied residential building were selected for the experiment. The joints were constructed without any shear reinforcement within the joint region to evaluate the contribution of concrete strength in bond stress between the longitudinal reinforcement and concrete. Bond stress has important specific roles on the ductility of the joint in particular and on the ductility of the global structure in general. The models were subjected to incremental static cyclic lateral loading provided by hydraulic jacks under constant axial loading. Deflections and rotations were measured by dial gauges and a video extensometer. It is found from the study that ductility of the structural members i.e. beams, columns and joints increased remarkably with increased concrete strength.

**Key words:** Concrete strength, ductility, interior joint, seismic loading

## ACKNOWLEDGEMENT

The authors express their deep appreciation to KSRM, Seven Circles (Bangladesh) Limited, Nutech Construction Chemicals Company Limited and Bangladesh Building Systems Limited for their material and technical support. The authors convey their gratitude to Bangladesh Army for financial grants and support in doing the experimental works. The authors also express their gratitude to all members of Concrete Laboratory, Civil Engineering Department, BUET for all types of material and technical supports. It would not be possible to complete the experiments without their assistance.

## 1.0 INTRODUCTION

Ductility is defined as the ability of a material to undergo large deformation without rupture before failure. Ductility can be defined with respect to strain, rotations, curvature and deflections. Strain based ductility definition depends on material while rotation and curvature depends on shape and size of the cross sections as well. Global ductility of the overall structure is derived from local ductility of structural members. In seismic design philosophy, the structures should have sufficient ductility to dissipate seismic energy. If a structure is ductile then it can undergo large deformations without rupture before

failure and will provide warning to the occupants. There are desired locations where structural damage is allowed to occur (ACI 2004, FEMA 273) which is called plastic hinges. Structural failure must not occur at the columns as failure in this region make the stability of the entire structure vulnerable and may lead to a catastrophic failure of the structure. Beam-column joints are at the intermediate level of strength hierarchy. The joint behavior exhibits a complex interaction between bond and shear. The forces acting in the joints and failure mechanism under seismic events are discussed in many literatures. Earthquake or seismic loading induces large shear stresses in the joint region by. Combined



effect of the shear stresses causes diagonal cracking when tensile stress exceeds the tensile strength of the concrete. Extensive cracking occurs due to load reversals under seismic event. The joints should be strengthened to move the failure to the beams. Such failure would be the best result for seismic upgrade and this means that very efficient ductile and energy dissipating mechanism is achieved which would maintain global integrity of the structure (Prota et al. 2004). The joint performance can be enhanced by proper seismic detailing and ensuring proper concrete confinement in joint region. As it is said that the structural ductility comes from the member ductility and member ductility is gained through the inelastic rotations. In seismic design, it is desired that the plastic hinges should occur at beams rather than in the columns (FEMA 273, Akguzel et al. 2007). It leads to the Strong Column-Weak Beam Strategy which can be achieved by proper detailing in columns, beams and at the joints. On the other hand, functional requirement of a joint, which is the zone of intersection of beam and columns, is to enable the adjoining members to develop and sustain their ultimate capacity. The joints should have adequate strength and stiffness to sustain the forces induced by the adjoining members. Detailing of the shear reinforcement in seismic design is discussed in various national and international codes. This experiment is undertaken to understand the roles of concrete strength on the overall ductility of the Reinforced Concrete (RC) Framed structures. An interior joint of a Six Storied Residential building is selected for the study.

**2.0 MATERIAL PROPERTIES**

**2.1 Sand**

Coarse Sylhet sand and fine river sands were used for all specimens of the present experiment. Two batches of sands were prepared for model preparation. Sylhet Sand and local river sand were mixed in 3:1 proportion as it is done in most of the construction works in Bangladesh. Absorption capacity of the sand samples was 4% but moisture contents varied widely due to monsoon rain. Moisture content of the aggregates was measured before mixing and water content of the fresh concretes was adjusted accordingly. Fineness Modulus (FM) values of two batches of mixed sands were found 2.64 and 2.71 respectively by sieve analysis. Gradations of the samples are shown in Fig.1.

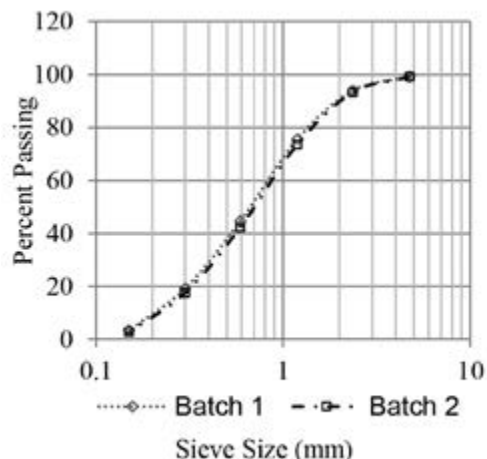

**Fig 1.** Grade of Fine Aggregates

**2.2 Coarse Aggregate**

The compressive strength of crushed stone aggregates is higher and provides better compressive strength of the concrete as well but 1<sup>st</sup> class ‘Jhama’ bricks having average compressive strength 26.29 MPa or 3810 psi were used for casting the models. Most of the buildings in Bangladesh are still constructed by coarse aggregates made from crushing the ‘Jhama’ bricks. Therefore, 10 mm down grade brick chips made from crushing first class bricks by hand were collected for model preparation. Specific gravity and absorption capacity of the coarse aggregate were 1.93 and 17.98% respectively.

**2.3 Cement**

For controlled and strengthened specimens Portland Cement CEM-I was used. The properties of the cement are given in Table 1.

**Table1.** Properties of Cement

Properties	Unit	
<b>Setting</b> (ASTM C191)	<b>Time</b> Minute	
Initial Setting Time	> 45	129
Final Setting Time	<375	266
<b>Strength</b> (ASTM C109)	<b>MPa</b>	
3 Days	> 12	24.95
7 Days	>19	35.20
28 Days	> 28	42.85

**2.4 Reinforcement**

Φ12 mm and Φ8 mm Grade 60/400 steel reinforcement was used for model construction in this exper-

iment. Samples were tested for yield and ultimate capacity. The test results are given in Table 2.

**Table 2.** Strength of Reinforcing Bars

Dia (mm)	Elongation (%)	Bar Area (mm <sup>2</sup> )	Yield Strength (MPa)	Ultimate Strength (MPa)
12	15.67	114.1	444	749
8	18	50.8	429	657

### 3.0 MODEL PREPARATION AND EXPERIMENTAL SET UP

#### 3.1 Model Selection

The models were selected considering a full scale six storied RC Frame Structured Building as shown in Fig.2. The story height of the building was 3100 mm and bay width was 4000 mm. The building was analyzed by ETABS 9.7 following ACI 318-05/IBC-2003. An interior joint from Storey-3 of the building was selected for the experimental program as shown in Fig.2. Considering the existing laboratory set up half scale model was selected. Dimensions of the half scale model are shown in Fig.3 and Fig.4. Dimensions and detailing of beam and column of the models are shown in Fig. 5 and Fig.6. The beams of the models had been made stronger than the column to observe the behavior of column failure.

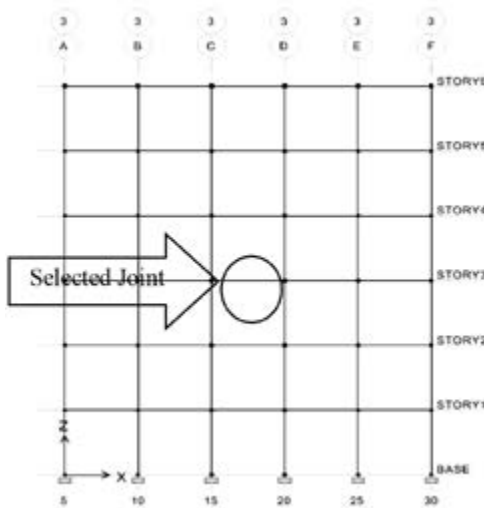

**Fig 2.** Global Structure

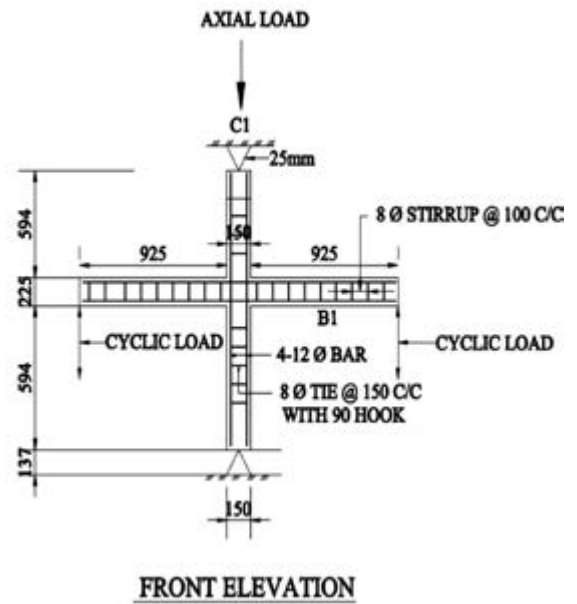

**Fig 3.** Dimensions of as Built Half Models

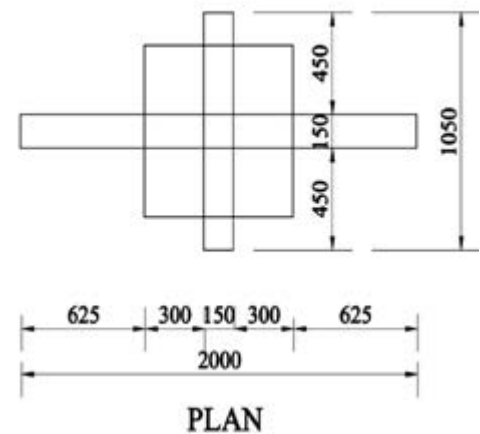

**Fig 4.** Plan View of as Built Half Models

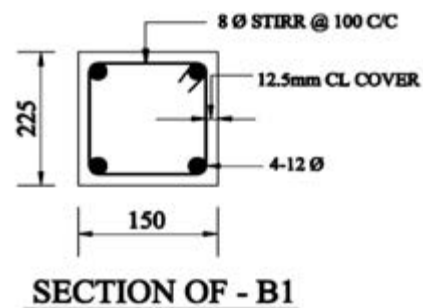

**Fig 5.** Details of Reinforcement of Beam

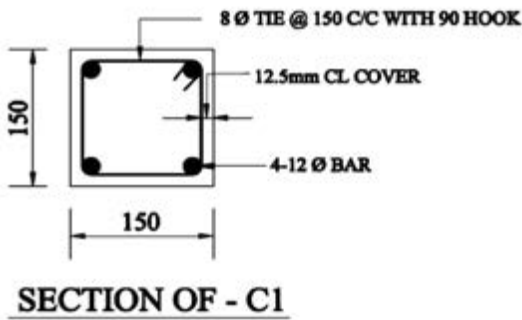

**Fig 6.** Details of Reinforcement of Column

**3.2 Model Preparation**

Two models were constructed for this experiment. The model will be designated as Model 1 and Model 2 in subsequent discussions. The model with lesser concrete strength is termed as Model 1 and the model with higher concrete strength is termed as Model 2. The form works, made of woods and ply woods, were used for casting the models. Lower column, beams and slabs were cast together as shown in Fig.7.

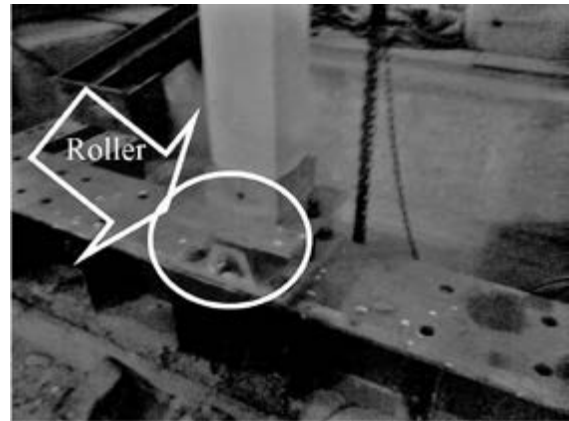

**Fig 7.** Concrete Casting of the Models

Water contents of fresh concretes were controlled by slump value to ensure better workability. Slump value varied between 50-75 mm. W/c ratios of Model 1 and Model 2 were 0.58 and 0.51 respectively. Fresh concretes were mechanically compacted. The models were cured for 28 days by wet jute cloth. To minimize the loss of moisture from the models, the formworks (Shuttering) were kept for 28 days. Average concrete strengths of Model 1 and Model 2 were found 18.31 MPa (2600 psi) and 28.31 MPa (4000 psi) respectively from the cylinder tests. Concrete strength of Model 2 was 54% more than that of Model 1.

**3.3 Experimental Set Up**

The models were placed on a steel base plate which had the arrangement of column seat. The base plate was intended to allow column rotation by incorporating roller at the bottom as shown in Fig.8.



**Fig 8.** Hinge Joint for Column Rotation

The base plate was fixed on a steel ‘I-Beam’ which was fixed with the concrete floor. A 50 kN capacity hydraulic jack was used to provide axial load on the column. Two manually operated hydraulic jacks were used to provide cyclic loading near the tip of the beams. Two sets of steel frames were designed for this experiment. They were fixed on both side of the column to arrest any horizontal movement of the column. A schematic view of the experimental set up is shown in Fig.9 and a detail view is shown in Fig.10.

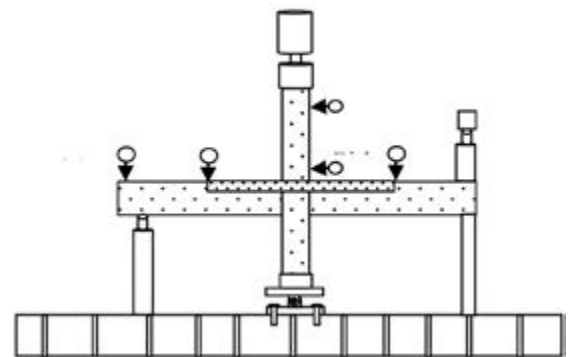

**Fig 9.** Schematic View of Experimental Set Up

Five dial gauges were used to measure the deflection of the beams and columns. First two dial gauges were set near the tip and at the beam-slab joint of the left beam. One dial gauge was fixed at the beam-slab joint of the right beam. Another two dial gauges were set at 10 cm below the column top and at 10 cm above the column-slab joint of the top column. Video extensometer was used to measure the rotation of the beam and column at the joint region. Video extensometer was placed closed

to the joint. “+” markings on the joint, as shown in the Fig.11, were used as the target to measure the beam and column joint rotation. The mark on the wooden plank was used to measure the absolute rotation of the specified target.



Fig 10. Detail View of Experimental Set Up

**3.4 Load Selection**

Strength of beam-column joint is influenced by the effective confinement of concrete. Column axial load also increases the confinement. To understand the behavior of all joints under identical condition, constant axial load of 10% of the column capacity ( $0.1f_c' A_g$ ) was applied. Axial loads for Model 1 and Model 2 were 45 and 65 kN respectively.

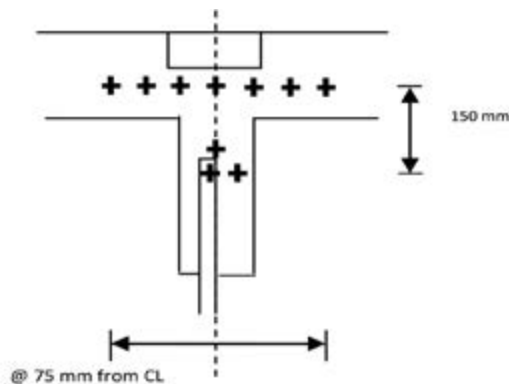

Fig 11. Schematic Diagram of Target for Video Extensometer

The static incremental cyclic loading was applied by two manually operated hydraulic jacks. The loading was controlled by measuring the column drift of the column top. 0.25%, 0.50%, 1% and 2% of the column drift were selected as the points of reversal for cyclic loading. Minimum division of the dial of hydraulic jacks was 5 kN (0.5 ton). Therefore, loading and unloading rate was 5 kN in a single increment. However, as the jacks were manually operated, loading and unloading could not be maintained at the same rate which may have influenced the result due to vis-

co-elastic effect. The load cycles are shown in Fig .12.

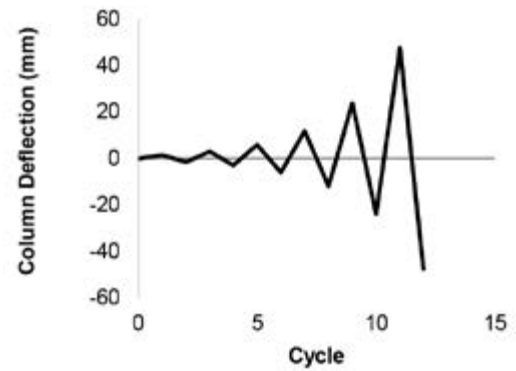

Fig 12. Loading Cycle of the Experiment

**4.0 EXPERIMENTAL RESULTS AND DISCUSSIONS**

**4.1 Force Deformation Behavior of Beams**

Few small flexural cracks were marked at the end of Cycle-3 on the right end of the beam of Model 1 as shown in Fig.14. However, the cracks in beams were severe in Model 2 and flexural and flexural shear cracks were marked at the end of Cycle-4 as shown in Fig.16. Beam deflections are measured at the tip and beam slab joint of both the models. The deflection at the tip are shown here.



Fig 14. Model 1 Beam before Loading



Fig 15. Model 1 Beam Cracks after Loading

Beam secant stiffness are calculated from P-Δ hysteresis plots as shown in Fig.17 and 18. Secant stiffness is defined as the ratio of the strength to the maximum displacement. Secant stiffness of the beams for each load-deflection cycle is measured by considering the maximum load and deflection of forward and reverse loading of each cycle and it is found that beam stiffness decreases in each subsequent cycles.



Fig 15. Model 2 before Loading



Fig 16. Model 2 Beam Cracks

Model 1 lost stiffness showing an abrupt drop whereas Model 2 lost stiffness gradually in subsequent cycles as shown in Fig. 19. Theoretical plastic moment capacities of the beams are calculated and plotted with their P-Δ curve obtained from the experiment as shown in Fig.20.

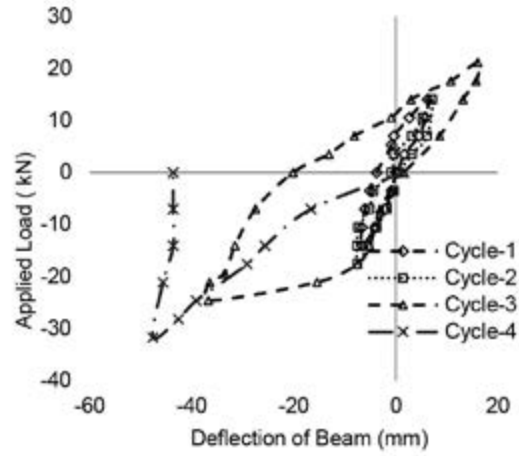

Fig 17. P-Δ Hysteresis Plot Beams Model 1

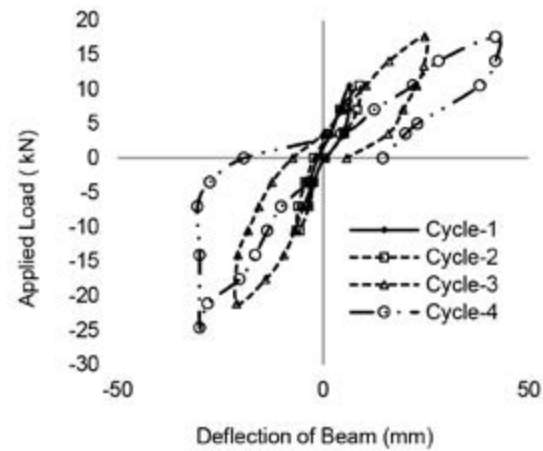

Fig 18. P-Δ Hysteresis Plot Beams Model 2

Performances of the beams in the present experiment are summarized in Table 3. It is found that beam of Model 2 exhibits better ductility than that of Model 1. The ductility of beam of Model 2 increased 46 %.

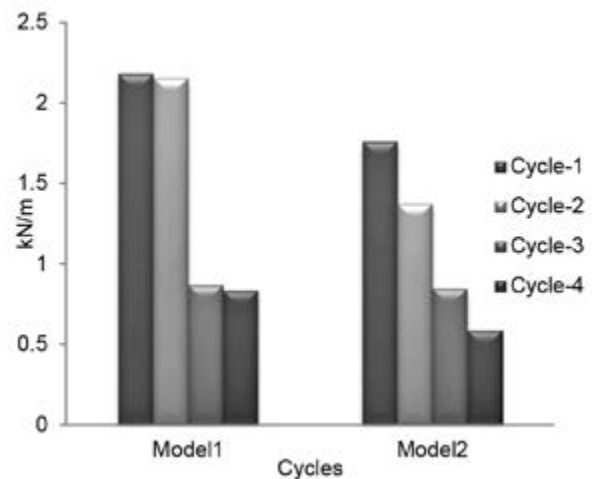

Fig 19. Stiffness of Beams

### 4.2 Force Deformation Behavior of Columns

Flexural and flexural-shear cracks developed in both upper and lower columns for both types of models under cyclic loading as shown in Fig.21 and Fig.23.

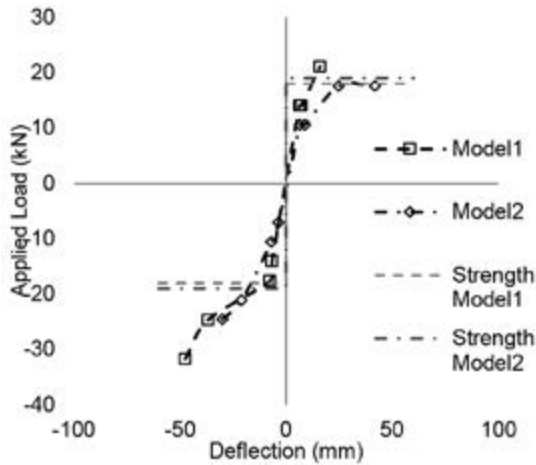

Fig 20. P-Δ behavior of Beams

Table 3. Ductility of Beams

Model No	First Crack		Condition of Failure		Ductility
	P (kN)	Δ (mm)	P (kN)	Δ (mm)	
Model 1	16	10.8	18.9	47.6	4.4
Model 2	10.5	6.5	17.6	42	6.46



Fig 21. Upper Column Failure, Model 1



Fig 22. Column of Model 2 before Loading



Fig 23. Column Failure, Model 2

From the load deflection hysteresis behavior of the columns, as shown in Fig.24 & 25, it is found that the column of Model 2 exhibited better ductile behavior as it deflected 30% higher than the column of Model 1 in forward loading and 26 % higher in reverse loading. Column deflection near the joint and at the tip were measured. Column secant stiffness were measured by considering maximum column shear and deflection for each cycle. Column shear is calculated from applied moment at the location of the dial gauge to measure the corresponding deflection. The computed stiffness is illustrated in Fig.26. It is found that, column of Model 2 lost stiffness gradually which indicates more ductile behavior. Plastic moment strengths of the columns are calculated and plotted with their P-Δ curve.

P-Δ curve of columns of Model 1 and Model 2 are shown in Fig.27. In forward cycle, both the samples experienced same column shear force but the column of Model 2 deflected 23% higher than column of Model 1. In reverse loading, column of Model 2, sustained 20% excess shear force while deflecting 22% higher than the column of Model 1. Column shear is calculated from the applied moment and corresponding deflection is measured. Performances of the columns are analyzed by the load-deflection hysteresis plots as shown in Fig.24 and 25.

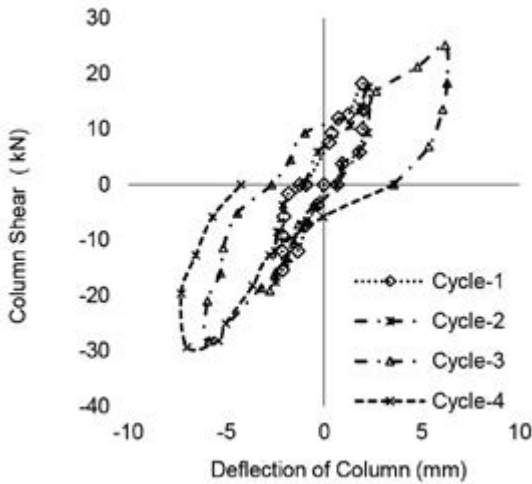

Fig 24. P-Δ Hysteresis Plot, Column (a) Model 1

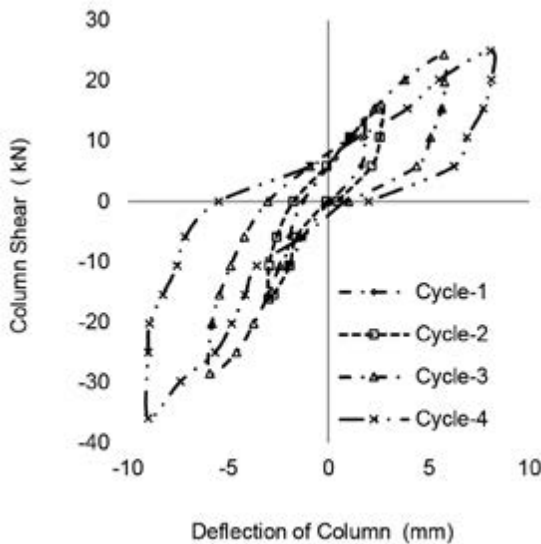

Fig 25. P-Δ Hysteresis Plot, Column Model 2

Column ductility is calculated from deflections measured at the appearance of the first crack and the deflection at failure. Performances of the columns in this experiment are shown in Table 4.

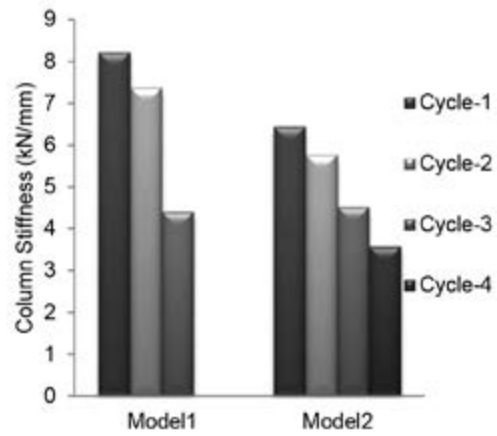

Fig 26. Column Stiffness

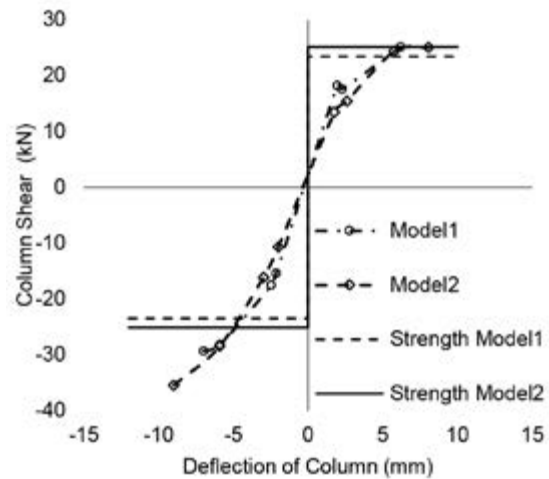

Fig 27. Load – Deflection Behavior of Column

It is found that Model 2 exhibits better ductility than that of Model 1. Column ductility was increased by 25% by increasing the concrete strength.

For both Model 1 and Model 2, ultimate failure occurred due to column failure while the beams were yet to reach their ultimate capacities. The column failed due the failure of the concrete by flexure-shear crack. It is observed from the experiment that in case of weaker column, the plastic hinge form in the column region. The beams were unable to transfer loads to the adjacent columns and the entire structure may collapse.

#### 4.3 Moment-Rotation (M-Φ) Behavior of Joints

Rotation (Φ) experienced by the joints in each cycle depends on the magnitude of the applied moment, M. Rotations of the beams and columns at the joints against corresponding loading (applied moment)



were measured by Video Extensometer.

**Table 4. Ductility of Columns**

Model No	First Crack		Condition of Failure		Ductility
	P (kN)	$\Delta$ (mm)	P (kN)	$\Delta$ (mm)	
Model 1	17.5	3.30	28	5.4	1.63
Model 2	15.44	5.6	36	11.4	2.03



**Fig 28. Joint Failure of Model 1**



**Fig 29. Joint Failure of Model 2**

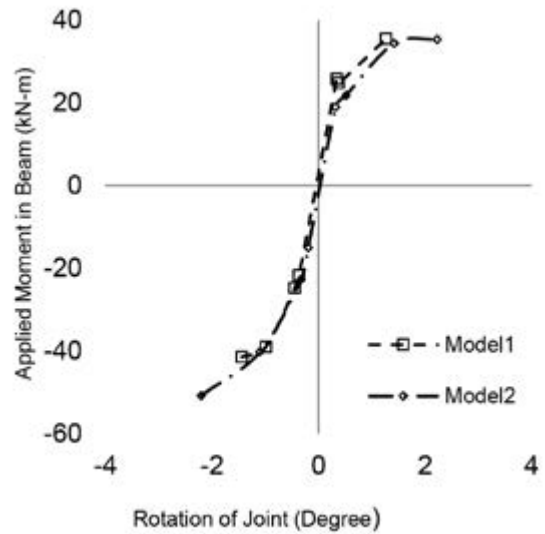

**Fig 30. M- $\Phi$  behavior of Column Joint**

Initially absolute rotation of the beam column joint was measured against time by video extensometer and relative rotations against the applied load and moment were calculated later. Both the joints exhibited diagonal shear cracks due to cyclic loading. Diagonal shear crack appeared in the first cycle in case of Model 1 whereas it appeared in the third cycle in case of Model 2. The cracks widened and propagated up to the transverse beams. Joint cracks approaching failure are shown in Fig. 23 and Fig.24. The difference in beam and column joints rotation is comparatively less within the elastic limit while the difference is greater in subsequent cycles. It is seen from the M- $\Phi$  curve that, beam and column joints of Model 2 rotates less against the same applied moment within the elastic limit whereas it rotates more than beam and column joint of Model 1 while approaching failure. It is found that, beam and column joint of Model 2 exhibit better ductility than the same of Model 1. Beam and column joint ductility increased by 68% and 136% respectively.

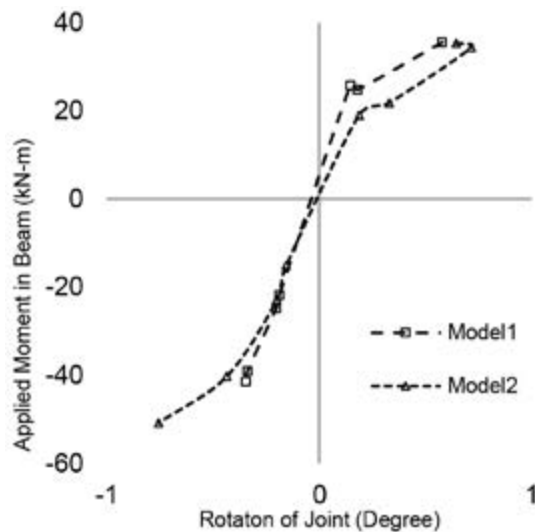

Fig 31. M- $\Phi$  behavior of Column Joint

## 5.0 CONCLUSIONS

It was observed that the beam, column and joint ductility increased due to the increased concrete strength. The joint exhibited better performance as the bond strength between the reinforcement and the concrete increased with increasing concrete strength. This experiment has shown ductility behavior of the structural member (beam, column and Joint) in case of varied concrete strength. In case of high strength concrete, the failure may be governed by reinforcement. The yield strength and elongation behavior of the steel reinforcement will govern the collapse behavior of the structure. A further study can be done by reinforcement failure. Following conclusions are drawn based on the experiment and analysis of the results:

a. Displacement ductility of the beam and column is increased by 46% and 25% respectively and rotational ductility of the beam and column joint is increased by 68% and 136% respectively by increasing the concrete strength from 18.31 MPa to 28.31 MPa i.e. 54% of the concrete strength.

b. Beam, column and joint stiffness of Model 2 decreased gradually under cyclic loading than Model 1. Therefore, concrete with high strength loses stiffness gradually under cyclic loading exhibiting better collapse behavior.

c. The experiments were carried out under some constraints. Only two models were prepared due to budget and labor constraint but it is found from the

experiment that, ductility of the structural members i.e. beam, column and their joints increased with the higher concrete strength. A detail further study can be undertaken by preparing more number of models with low and high strength concrete and observing both concrete and reinforcement failure.

## References:

- [1] American Concrete Institute (ACI)-ASCE Committee 352. (2002). "Recommendations for Design of Beam-Column Connections in Monolithic Reinforced Concrete Structures." ACI 352R-02, Farmington Hills, MI.
- [2] American Concrete Institute (ACI) Committee 318. (2002). "Building code requirements for structural concrete and commentary." ACI 318-02 and ACI 318R-02, Farmington Hills, MI.
- [3] Akguzel, U., and Pampanin, S. (2007). "Seismic Response of RC Beam-Column Joints Upgraded with FRP Sheets. II: Analysis and Parametric Study." ASCE, Journal of Composites for Construction, Vol. 11, No 6, pp. 590-600.
- [4] Akguzel, U., and Pampanin, S. (2012). "Assessment and Design Procedure for the Seismic Retrofit of Reinforced Concrete Beam-Column Joints using FRP Composite materials." ASCE, Journal of Composites for Construction, Vol. 16, No 1, pp. 21-34.
- [5] Cosgun, C., Cumhur, C., Comert, M., Mustafa, D., Demeir, C., and Ilki, A. (2012). "FRP Retrofit of a Full Scale 3D RC Frame," Istanbul Technical University.
- [6] Eligehausen, R., Popov, E.P., and Bertero, V.V. (1983). "Local Bond Stress-slip Relationships of Deformed Bars under Generalised Excitations." Report UCB/EERC-83/19, Earthquake Engineering Research Center, University of California, Berkeley, 178p.
- [7] Federal Emergency Management Agency (FEMA). (1997). "NEHRP Guidelines for Seismic Rehabilitation of Buildings October." FEMA 273.
- [8] Hakuto, S., Park, R., and Tanaka, H. (2000). "Seismic Load Tests on Interior and Exterior Beam-Column Joints with Substandard Reinforcing Details." Structural Journal, ACI, 97(1), pp11-25.
- [9] Ichinose, T. (1991). "Interaction between Bond at Beam Bars and Shear Reinforcement in RC Interior Joints, Design of Beam-Column Joints for Seismic Resistance." SP-123, American Concrete Institute, Farmington Hills, Mich., pp. 379-400.
- [10] Leon, R.T. (1990). "Shear Strength and Hysteretic Behavior of Beam-Column Joints," ACI Structural Journal, Jan-Feb, vol.87, No.1, pp. 3-11.
- [11] Nilson, H. Arthur. (1997). "Design of Concrete Structures." 12 Edition, chap 10, pp 332-358, The McGraw-Hill Companies, Inc, New York.
- [12] Neville, A.M. (1995). "Properties of Concrete," chap 3, pp 108-120, 4th Edition, Pearson Education, Inc, Nodia, India.
- [13] Prota, A., Nanni, T., Anotnia, G., Gaetano, M., Manfredi, V., and

Cosenza, Edoward. (2004). "Selective upgrade of under Designed Reinforced Concrete Beam-Column Joints Using Carbon Fiber Reinforced Polymers." ACI Structural Journal, Sep-Oct vol 101, No 5, pp 699-707.

[14] Paulay, T., and Priestley, M.J.N. (1992). "Seismic Design of Reinforced Concrete and Masonry Buildings," John Wiley publications New York.

[15] Uma, S.R., and Prasad, A.Meher., (2005). "Seismic Behavior of Beam Column Joints in Reinforced Concrete Moment Resisting Frames." document no IITK-GSDMA-EQ-31-V1-0, IITK-GSDMA Project on Building Code.

### **General**

- The article must be original, unpublished (or sent for publication elsewhere) in whole or in part. It should contain author's own findings, recommendations.
- The article should be related to "Science and Technology".
- Font should be Arial, or Calibri, or Verdana, or similar to these. (There might be slight changes during editing and composing)
- All manuscripts must be in English, double column, and in MS Word format.
- The article should be free from any political remarks, any individual satire.
- Articles will be published after the review process by nominated reviewers.
- For further queries and examples please visit MIST website. ([www.mist.ac.bd](http://www.mist.ac.bd)> R&D Wing> MIST Journal).

### **Abstract**

- Abstract should be the brief of the original article.
- Length should normally be within 150-200 words.
- Do not include references in abstract.

### **Acknowledgement**

- Acknowledgement may be given (if any) after Abstract.

### **Keywords**

- Keywords should be cited below the abstract as appropriate.

### **Full Article**

- The arrangement of the writing is up to the authors.
- The length of the article should not normally exceed 7,000 words.
- For details about group heading, paragraph numbers, paragraph heading, sub-para number, sub-para heading, figure number, figure title, table number, etc. Please see our previous publications
- Proper color to be used where needed.

### **Tables**

- Tables should be in MS word table format.
- MS Excel can also be used for graphical representation of data.

### **Figures and Pictures**

- Figures and pictures should be pasted in the main article as desired by the author.
- Copy of figures and pictures should be sent as separate files (jpg format) which can be used to compose the publication for a clear and bright print.

### **Items to Send to the Executive Editor**

- 1x Bio-data with 1copy passport size photograph for each author.
- 1x hard copy of the article with hand signature of the author/authors at the last page.
- 1xsoft copy in a CD containing all files used to compile the article. It may include word document, excel document, jpg files, etc.



# INDEX

SL	ARTICLE	PAGE NO
1.	THE NULL EFFECT OF CROSS SECTIONS OTHER THAN THE MAXIMUM PITTED CROSS SECTION ON STRENGTH REDUCTION OF AGED MARINE PLATES SUBJECTED TO UNIAXIAL TENSILE LOADING Commodore M Munir Hassan (Retd), Tasmia Hoque and Lieutenant Colonel Muhammad Rabiul Islam, PhD	1
2.	BEHAVIOR OF CONCRETE FILLED STAINLESS STEEL TUBULAR COLUMN UNDER AXIAL LOADS Lieutenant Colonel Muhammad Sanaullah, Jesika Rahman, Ibriju Ibrahim and Major Md. Soebur Rahman	9
3.	ASSESSMENT OF FUTURE WATER DEMAND OF DHAKA CITY Lieutenant Colonel Md Ehsanul Haque	19
4.	ACCOUNTING INFORMATION SYSTEM (AIS) PRACTICES AND ITS EFFECTS ON SMES: THE BANGLADESH HANDLOOM INDUSTRY EXPERIENCE Md. Ismail Hossain and Major Md. Ferdousur Rahman PhD	29
5.	SUSTAINABLE FINANCE FOR GROWTH AND DEVELOPMENT OF BANKING INDUSTRY IN BANGLADESH: AN EQUITY PERSPECTIVE Dr. Mohammad Zahir Raihan	41
6.	LOCAL RESIDENT'S ATTITUDES TOWARDS THE IMPACT OF TOURISM DEVELOPMENT: A STUDY OF SAINT MARTIN ISLAND, BANGLADESH Masum Miah and Mst. Jannatul Mawa	52
7.	APPLICATION OF SPACE SYNTAX ANALYSIS IN LALBAGH Sabbir Ahmed	66
8.	ORGANIZATION AND MANAGEMENT PRACTICES OF UNIVERSITY LIBRARIES IN BANGLADESH: AN EVALUATION Lieutenant Colonel Muhammad Sanaullah and Md. Moslem Uddin	73
9.	SPATIAL ANALYSIS OF THE INTEGRATION CORE OF COMILLA CITY CORPORATION AREA AND THE IMPACT OF THE BY-PASS ROAD - A SPACE SYNTAX ANALYSIS Ishrat Zerine Hossain Mou	83
10.	EXPERIMENTAL INVESTIGATION ON THE IMPACT OF CONCRETE STRENGTH ON THE DUCTILITY OF REINFORCED CONCRETE FRAME STRUCTURES Lieutenant Colonel Bhuiyan Mohammad Golam Kibria	104